



## Temperature



- HD 2107.1, HD 2107.2, HD 2127.1, HD 2127.2, HD 2307.0 Portable instruments for Pt100 probes	pag. 6
- Probes with Pt100 sensor	pag. 9
- HD 2108.1, HD 2108.2, HD 2128.1, HD 2128.2, HD 2328.0 Portable instruments for Thermocouple probes	pag. 14
- Thermocouple Probes	pag. 17
- HD 2178.1, HD 2178.2 Portable instruments for Pt100 probes and Thermocouple probes	pag. 22
- HD 32.7 Data logger with 8 inputs for Pt100 probes	pag. 24
- HD 32.8.8 - HD 32.8.16 Datalogger with 8 or 16 inputs for Thermocouple probes	pag. 25
- HD 788TR1, HD 788TR1.I, HD 786TR1, HD 988TR1, HD 988TR1.I, HD 988TR2 Configurable Pt100 temperature transmitters, output 4÷20mA., HD688T Pt100 sensor opto-isolated transmitter	pag. 27
- HD 688T Modular temperature transmitter	pag. 29
- HD 2047 Pt100 simulator	pag. 30
- HD 778TR1, HD 978TR1, HD 978TR2, HD 778 T CAL Configurable 4÷20mA output temperature transmitters for Thermocouples	pag. 32
- HD 978TR3, HD 978TR4, HD 978TR5, HD 978TR6 Configurable 4÷20mA or 0÷10Vdc signal amplifiers, converters	pag. 34
- HD 9022, DO 9404 Indicators, Regulators	pag. 36
• Accredited Laboratory SIT Centre 124 in Temperature	pag. 42



**HD2107.1, HD2107.2, HD2127.1 E HD2127.2  
THERMOMETERS SENSORS: Pt100, Pt1000**

L'HD2107.1 and l'HD2107.2 are portable instruments equipped with large LCD display fitted with one input. HD2127.1 and HD2127.2 are instruments fitted with two inputs. They measure temperature by means of immersion, penetration, contact or air probes. Their sensor can be Pt100 with 3 or 4 wires, Pt1000 with 2 wires.

Probes are equipped with an automatic recognition module: factory calibration data are stored inside.

The instruments HD2107.2 and HD2127.2 are **data loggers**; they store up to 80.000 samples which can be transferred into a PC connected to the instrument through a multi-standard RS232C serial port and a USB 2.0. It is possible to configure the storage interval, the printing and the baud rate by the menu.

All models are equipped with RS232C serial port and are able to transfer the acquired measures, in real time, into a PC or a portable printer.

Functions Max, Min and Avg calculate maximum, minimum and average values. Further functions are: REL relative measure, HOLD and automatic switching-off system, excludable.

**Instruments have IP67 protection degree.**

**TECHNICAL SPECIFICATIONS OF THE INSTRUMENTS**

*Instrument*

Dimensions	185x90x40mm
(Length x Width x Height)	
Weight	470g (complete with batteries)
Materials	ABS, rubber
Display	2x4½ digits plus symbols Visible area: 52x42mm

*Operating conditions*

Operating temperature	-5 ... 50°C
Storage temperature	-25 ... 65°C
Working relative humidity	0 ... 90% RH, no condensation
<b>Protection degree</b>	<b>IP67</b>

*Power supply*

Batteries	4 Batteries 1.5V type AA
Autonomy	200 hours with 1800mAh alkaline batteries
Current consumption with instrument off	20µA
Main	12Vdc / 1000mA Output main adapter

*Unit of measurement*

°C - °F - °K

*Security of data stored*

Unlimited, independent of battery charge conditions

*Time*

Date and time	Schedule in real time
Accuracy	1min/month max drift

*Measured values storage*

*model HD2107.2*

Type	2000 pages containing 40 samples each
Quantity	Total of 80000 samples
Storage interval	1s...3600s (1 hour)

*model HD2127.2*

Type	2000 pages containing 16 pairs of samples each
Quantity	Total of 32000 samples (channel A + channel B)
Storage interval	1s...3600s (1 hour)

*Serial interface RS232C*

Type	RS232C electrically isolated
Baud rate	can be set from 1200 to 38400 baud
Data bit	8
Parity	None
Stop bit	1
Flow Control	Xon/Xoff
Serial cable length	Max 15m
Immediate print interval	1s ... 3600s (1 hour)

*USB interface - model HD2107.2, HD2127.2*

Type	1.1 - 2.0 electrically isolated
------	---------------------------------

*Connections*

Input module for the probes	8-pole male DIN45326 connector
Serial interface and USB	8-pole MiniDin connector
Mains adapter	2-pole connector (positive at centre)

*Measurement of temperature by Instrument*

Pt100 measurement range	-200...+650°C
Pt1000 measurement range	-200...+650°C
<b>Resolution</b>	<b>0.01°C in the range ±199.99°C</b> <b>0.1°C in the remaining range</b>
Instrument Accuracy	±0.01°C
Drift after 1 year	0.1°C/year



**TECHNICAL DATA OF PROBES AND MODULES EQUIPPED WITH INSTRUMENT**  
**Temperature probes Pt100 sensor with SICRAM module**

Model	Type	Application field	Accuracy
TP472I	Immersion	-196°C...+500°C	±0.25°C (-196°C...+350°C) ±0.4°C (+350°C...+500°C)
TP472I.0	Immersion	-50°C...+400°C	±0.25°C (-50°C...+350°C) ±0.4°C (+350°C...+400°C)
TP473P	Penetration	-50°C...+400°C	±0.25°C (-50°C...+350°C) ±0.4°C (+350°C...+400°C)
TP473P.0	Penetration	-50°C...+400°C	±0.25°C (-50°C...+350°C) ±0.4°C (+350°C...+400°C)
TP474C	Contact	-50°C...+400°C	±0.3°C (-50°C...+350°C) ±0.4°C (+350°C...+400°C)
TP474C.0	Contact	-50°C...+400°C	±0.3°C (-50°C...+350°C) ±0.4°C (+350°C...+400°C)
TP475A.0	Air	-50°C...+250°C	±0.3°C (-50°C...+250°C)
TP472I.5	Immersion	-50°C...+400°C	±0.3°C (-50°C...+350°C) ±0.4°C (+350°C...+400°C)
TP472I.10	Immersion	-50°C...+400°C	±0.30°C (-50°C...+350°C) ±0.4°C (+350°C...+400°C)
TP49A	Immersion	-70°C...+400°C	±0.25°C (-50°C...+350°C) ±0.4°C (+350°C...+400°C)
TP49AC	Contact	-70°C...+400°C	±0.25°C (-50°C...+350°C) ±0.4°C (+350°C...+400°C)
TP49AP	Penetration	-70°C...+400°C	±0.25°C (-50°C...+350°C) ±0.4°C (+350°C...+400°C)
TP875	Globe-thermometer Ø150mm	-30°C...+120°C	±0.25°C
TP876	Globe-thermometer Ø 50mm	-30°C...+120°C	±0.25°C
TP87	Immersion	-50°C...+200°C	±0.25°C
TP878 TP878.1	For solar panels	+5°C...+80°C	±0.25°C
TP879	For compost	-20°C...+120°C	±0.25°C

*Common features*

Temperature drift @20°C 0.003%/°C

**4 wires Pt100 and 2 wires Pt1000 Probes**

Model	Type	Application field	Accuracy
TP47.100	4 wires Pt100	-50...+400°C	Class A
TP47.1000	2 wires Pt1000	-50...+400°C	Class A

*Common features*

Temperature drift @20°C

Pt100 0.003%/°C

Pt1000 0.005%/°C

**PURCHASING CODES**

**HD2107.1:** The kit consists of instrument HD2107.1, 4 per 1.5V alkaline Batteries, instruction manual, case and DeltaLog9 software. **Probes and cables have to be ordered separately.**

**HD2107.2:** The kit consists of instrument HD2107.2 **data logger**, 4 per 1.5V alkaline Batteries, instruction manual, case and DeltaLog9 software. **Probes and cables have to be ordered separately.**

**HD2127.1:** The kit consists of instrument HD2127.1, 4 per 1.5V alkaline Batteries, instruction manual, case and DeltaLog9 software. **Probes and cables have to be ordered separately.**

**HD2127.2:** The kit consists of instrument HD2127.2 **data logger**, 4 per 1.5V alkaline Batteries, instruction manual, case and DeltaLog9 software. **Probes and cables have to be ordered separately.**

**HD2110CSNM:** 8-pole connection cable MiniDin - Sub D 9-pole female for RS232C.

**C.206:** Cable for instruments of the series HD21...1 and .2 to connect directly to USB input of PC.

**HD2101/USB:** Connection cable USB 2.0 connector type A - 8-pole MiniDin.

**DeltaLog9:** Software for download and management of the data on a PC using Windows 98 to XP and Vista operating systems.

**SWD10:** Stabilized power supply at 230Vac/12Vdc-300mA-1000mA mains voltage.

**HD40.1:** Upon request, portable, serial input, 24 column thermal printer, 58mm paper width.

**Probes equipped with SICRAM module**

**TP472I:** Immersion probe, Pt100sensor. Stem Ø 3 mm, length 300 mm. Cable 2 meters long.

**TP472I.0:** Immersion probe, Pt100sensor. Stem Ø 3 mm, length 230 mm. Cable 2 meters long.

**TP473P:** Penetration probe, Pt100sensor. Stem Ø 4mm, length 150 mm. Cable 2 meters long.

**TP473P.0:** Penetration probe, Pt100sensor. Stem Ø 4mm, length 150 mm. Cable 2 meters long.

**TP474C:** Contact probe, Pt100sensor. Stem Ø 4mm, length 230mm, contact surface Ø 5mm. Cable 2 meters long.

**TP474C.0:** Contact probe, Pt100sensor. Stem Ø 4mm, length 230mm, contact surface Ø 5mm. Cable 2 meters long.

**TP475A.0:** Air probe, Pt100sensor. Stem Ø 4mm, length 230mm. Cable 2 meters long.

**TP472I.5:** Immersion probe, Pt100sensor. Stem Ø 6mm, length 500 mm. Cable 2 meters long.

**TP472I.10:** Immersion probe, Pt100sensor. Stem Ø 6mm, length 1,000mm. Cable 2 meters long.

**TP49A:** Immersion probe, Pt100sensor. Stem Ø 2.7mm, length 150mm. Cable 2 meters long. Aluminium handle.

**TP49AC:** Contact probe, Pt100sensor. Stem Ø 4 mm, length 150mm. Cable 2 meters long. Aluminium handle.

**TP49AP:** Penetration probe, Pt100sensor. Stem Ø 2.7mm, length 150mm. Cable 2 meters long. Aluminium handle.

**TP875:** Globe thermometer Ø 150 mm with handle. Cable 2 meters long.

**TP876:** Globe thermometer Ø 50 mm with handle. Cable 2 meters long.

**TP87:** Immersion probe, Pt100sensor. Stem Ø 3 mm, length 70 mm. Cable 2 meters long.

**TP878:** Contact probe for solar panels. Cable 2 meters long.

**TP878.1:** Contact probe for solar panels. Cable 5 meters long

**TP879:** Penetration probe for compost. Stem Ø 8 mm, length 1 meter. Cable 2 meters long.

**Temperature probes without SICRAM module**

**TP47.100:** Direct 4 wires Pt100 sensor immersion probe. Stem Ø 3 mm, length 230mm. 4 wires connection cable with connector, 2 meters long.

**TP47.1000:** Pt1000 sensor immersion probe. Stem Ø 3 mm, length 230mm. 2 wires connection cable with connector, 2 meters long.

**TP47:** Only connector for probe connection without SICRAM module: direct 3 and 4 wires Pt100, 2 wires Pt1000.

Temperature



TP875



HD40.1





### TECHNICAL SPECIFICATIONS OF PROBES AND MODULES EQUIPPED WITH INSTRUMENT

Temperature probes Pt100 sensor with SICRAM module

Model	Type	Application field	Accuracy
TP472I	Immersion	-196°C...+500°C	±0.25°C (-196°C...+350°C) ±0.4°C (+350°C...+500°C)
TP472I.0	Immersion	-50°C...+400°C	±0.25°C (-50°C...+350°C) ±0.4°C (+350°C...+400°C)
TP473P	Penetration	-50°C...+400°C	±0.25°C (-50°C...+350°C) ±0.4°C (+350°C...+400°C)
TP473P.0	Penetration	-50°C...+400°C	±0.25°C (-50°C...+350°C) ±0.4°C (+350°C...+400°C)
TP474C	Contact	-50°C...+400°C	±0.3°C (-50°C...+350°C) ±0.4°C (+350°C...+400°C)
TP474C.0	Contact	-50°C...+400°C	±0.3°C (-50°C...+350°C) ±0.4°C (+350°C...+400°C)
TP475A.0	Air	-50°C...+250°C	±0.3°C (-50°C...+250°C)
TP472I.5	Immersion	-50°C...+400°C	±0.3°C (-50°C...+350°C) ±0.4°C (+350°C...+400°C)
TP472I.10	Immersion	-50°C...+400°C	±0.30°C (-50°C...+350°C) ±0.4°C (+350°C...+400°C)
TP49A	Immersion	-70°C...+400°C	±0.25°C (-50°C...+350°C) ±0.4°C (+350°C...+400°C)
TP49AC	Contact	-70°C...+400°C	±0.25°C (-50°C...+350°C) ±0.4°C (+350°C...+400°C)
TP49AP	Penetration	-70°C...+400°C	±0.25°C (-50°C...+350°C) ±0.4°C (+350°C...+400°C)
TP875	Globe-thermometer Ø150mm	-30°C...+120°C	±0.25°C
TP876	Globe-thermometer Ø 50mm	-30°C...+120°C	±0.25°C
TP87	Immersion	-50°C...+200°C	±0.25°C
TP878 TP878.1	For solar panels	+5°C...+80°C	±0.25°C
TP879	For compost	-20°C...+120°C	±0.25°C

**Common features**  
Temperature drift @20°C 0.003%/°C

#### 4 wires Pt100 and 2 wires Pt1000 Probes

Model	Type	Application field	Accuracy
TP47.100	4 wires Pt100	-50...+400°C	Class A
TP47.1000	2 wires Pt1000	-50...+400°C	Class A

**Common features**  
Temperature drift @20°C  
Pt100 0.003%/°C  
Pt1000 0.005%/°C

#### PURCHASING CODES

**HD2307.0:** The kit consists of instrument HD2307.0, 3 per 1.5V alkaline Batteries, instruction manual and case. **Probes have to be ordered separately.**

#### Probes equipped with SICRAM module

- TP472I:** Immersion probe, Pt100sensor. Stem Ø 3 mm, length 300 mm. Cable 2 meters long.
- TP472I.0:** Immersion probe, Pt100sensor. Stem Ø 3 mm, length 230 mm. Cable 2 meters long.
- TP473P:** Penetration probe, Pt100sensor. Stem Ø 4mm, length 150 mm. Cable 2 meters long.
- TP473P.0:** Penetration probe, Pt100sensor. Stem Ø 4mm, length 150 mm. Cable 2 meters long.
- TP474C:** Contact probe, Pt100sensor. Stem Ø 4mm, length 230mm, contact surface Ø 5mm. Cable 2 meters long.
- TP474C.0:** Contact probe, Pt100sensor. Stem Ø 4mm, length 230mm, contact surface Ø 5mm. Cable 2 meters long.
- TP475A.0:** Air probe, Pt100sensor. Stem Ø 4mm, length 230mm. Cable 2 meters long.
- TP472I.5:** Immersion probe, Pt100sensor. Stem Ø 6mm, length 500 mm. Cable 2 meters long.
- TP472I.10:** Immersion probe, Pt100sensor. Stem Ø 6mm, length 1,000mm. Cable 2 meters long.
- TP49A:** Immersion probe, Pt100sensor. Stem Ø 2.7mm, length 150mm. Cable 2 meters long. Aluminium handle.
- TP49AC:** Contact probe, Pt100sensor. Stem Ø 4 mm, length 150mm. Cable 2 meters long. Aluminium handle.
- TP49AP:** Penetration probe, Pt100sensor. Stem Ø 2.7mm, length 150mm. Cable 2 meters long. Aluminium handle.
- TP875:** Globe thermometer Ø 150 mm with handle. Cable 2 meters long.
- TP876:** Globe thermometer Ø 50 mm with handle. Cable 2 meters long.
- TP87:** Immersion probe, Pt100sensor. Stem Ø 3 mm, length 70 mm. Cable 2 meters long.
- TP878:** Contact probe for solar panels. Cable 2 meters long.
- TP878.1:** Contact probe for solar panels. Cable 5 meters long
- TP879:** Penetration probe for compost. Stem Ø 8 mm, length 1 meter. Cable 2 meters long.

#### Temperature probes without SICRAM module

- TP47.100:** Direct 4 wires Pt100 sensor immersion probe. Stem Ø 3 mm, length 230mm. 4 wires connection cable with connector, 2 meters long.
- TP47.1000:** Pt1000 sensor immersion probe. Stem Ø 3 mm, length 230mm. 2 wires connection cable with connector, 2 meters long.
- TP47:** Only connector for probe connection: direct 3 and 4 wires Pt100, 2 wires Pt1000.



## HD2307.0

### THERMOMETER SENSORS: Pt100, Pt1000

L'HD2307.0 is a portable instrument equipped with large LCD display. It measures temperature by means of immersion, penetration, contact or air probes. Its sensor can be 3 or 4 wires Pt100, Pt1000. Probes are equipped with an automatic recognition module: factory calibration data are stored inside. The *Max*, *Min* and *Avg* function calculate the maximum, minimum or average values. Other functions include: the relative measurement REL, the HOLD function, and the automatic switching-off system, excludable. **The instrument has IP67 protection degree.**

#### TECHNICAL SPECIFICATIONS OF THE INSTRUMENTS

##### Instrument

<b>Dimensions</b>	
(Length x Width x Height)	140x88x38mm
Weight	160g (complete with Batteries)
Materials	ABS
Display	2x4½ digits plus symbols Visible area: 52x42mm
<b>Operating conditions</b>	
Operating temperature	-5 ... 50°C
Storage temperature	-25 ... 65°C
Working relative humidity	0 ... 90% RH, no condensation
<b>Protection degree</b>	<b>IP67</b>
<b>Power supply</b>	
Batteries	3 Batteries 1.5V type AA
Autonomy	200 hours with 1800mAh alkaline batteries
Current consumption with instrument off	< 20µA

**Unit of measurement** °C - °F







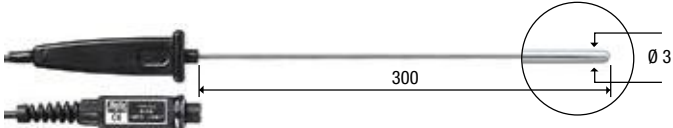

##### Connections

Module input for probes DIN45326 8 poles male Connector

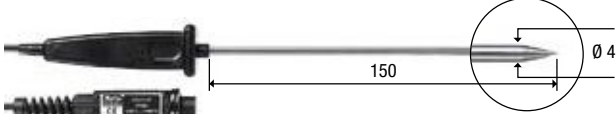
##### Measurement of temperature by Instrument

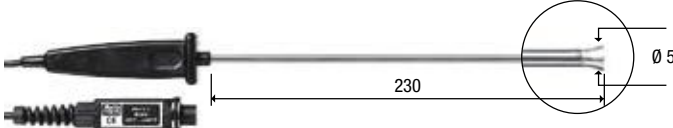
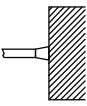
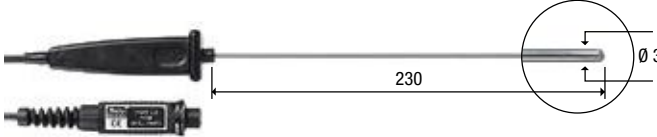
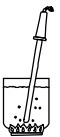
Pt100 measurement range	-200...+650°C
Pt1000 measurement range	-200...+650°C

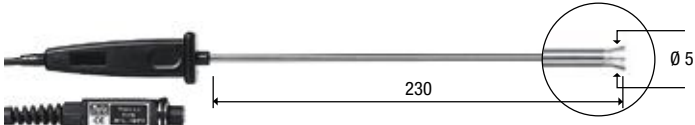
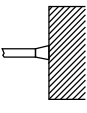
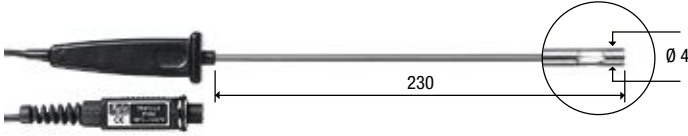

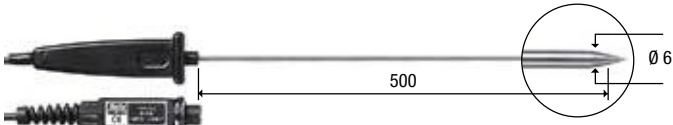
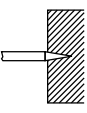
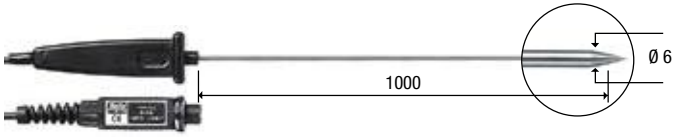
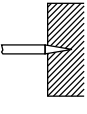
## PT100 PROBES FOR PORTABLE INSTRUMENTS EQUIPPED WITH SICRAM MODULE

CODE	°C max	$\tau$ s	DIMENSIONS	USE
TP 472 I	-196 +500	3s		
TP 473 P	-50 +400	5s		
TP 474 C	-50 +400	5s		
TP 472 I.O	-50 +400	3s		
TP 473 P.O	-50 +400	5s		
TP 474 C.O	-50 +400	5s		
TP 475 A.O	-50 +250	12s		
TP 472 I.5	-50 +400	3s		
TP 472 I.10	-50 +400	3s		



Temperature

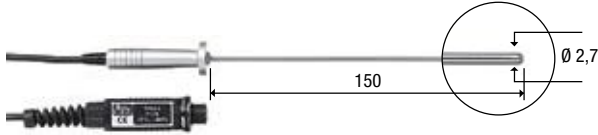
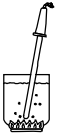
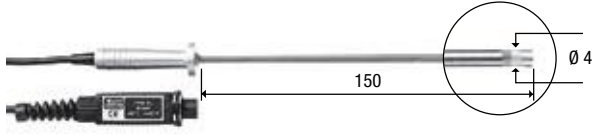
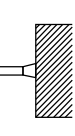
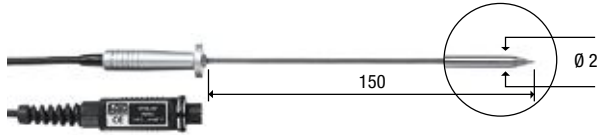
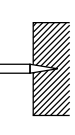
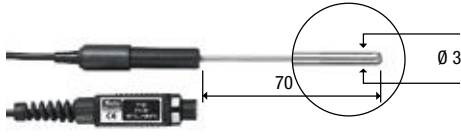
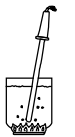
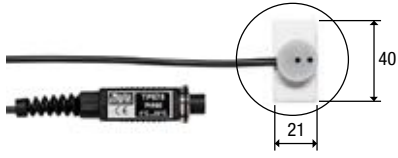
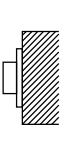
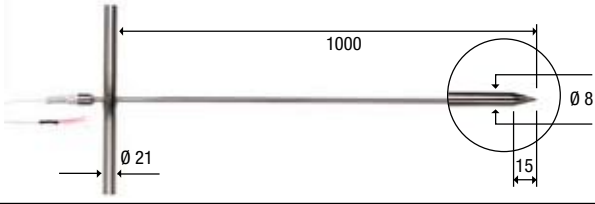
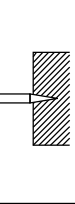





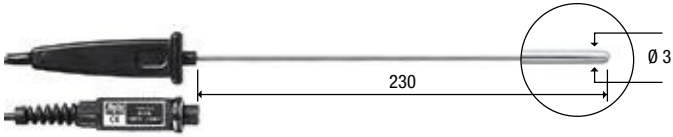





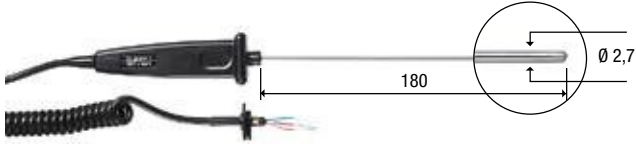
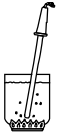
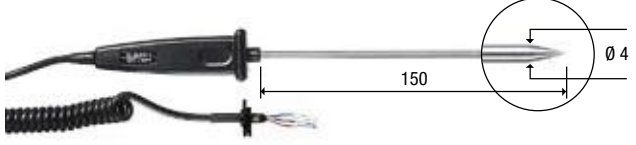

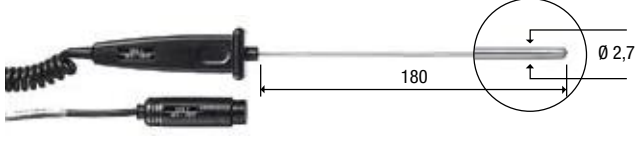

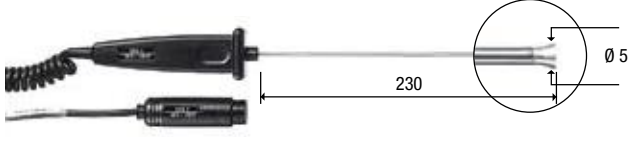

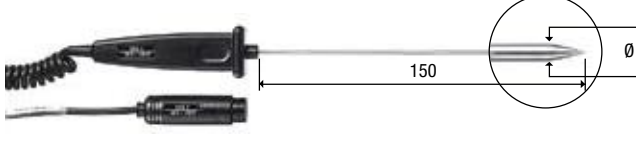
## Pt100 PROBES FOR PORTABLE INSTRUMENTS EQUIPPED WITH SICRAM MODULE

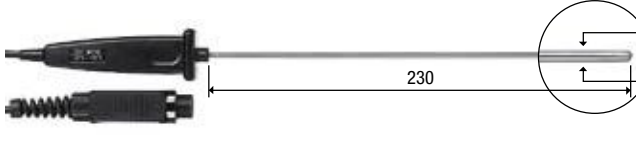
CODE	°C max	$\tau$ s	DIMENSIONS		USE
TP 49 A	-70 +400	3,5s			
TP 49 AC	-70 +400	5,5s			
TP 49 AP	-70 +400	4s			
TP 87	-50 +200	3s			
TP 878	+5 +80	60s	Contact probe for solar panels. Cable L = 2m.		
TP 878.1	+5 +80	60s	Contact probe for solar panels. Cable L = 5m.		
TP879	-20 +120	60s	Penetration probe for compost. Cable L = 2m 		
TP 875	-30 +120	15s	Globe-thermometer probe for measuring radiant heat $\varnothing$ 150 mm. (ISO7243, ISO7726). 4 wires Pt100 Sensor cable L=2m. <b>Equipped with SICRAM module.</b> 		
TP 876	-30 +120	15s	Globe-thermometer probe for measuring radiant heat $\varnothing$ 50 mm. (ISO7243, ISO7726). 4 wires Pt100 Sensor cable L=2m. <b>Equipped with SICRAM module.</b> 		

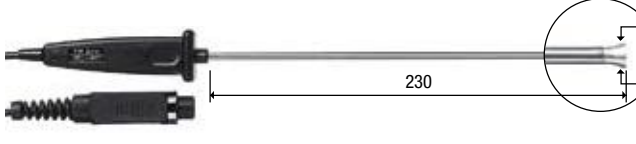
## Pt100 / Pt1000 SENSOR PROBES WITH TP 47 MODULE

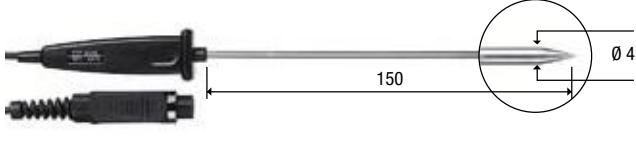
CODE	°C max	$\tau$ s	DIMENSIONS	USE
TP 47.100 (Pt100) TP 47.1000 (Pt1000)	-50 +400	3s		
TP 47	Only connector for connection of probes without SICRAM module: direct 3 and 4 wires Pt100, 2 wires Pt1000.			

## Pt100 SENSOR PROBES FOR OBSOLETE INSTRUMENTS

CODE	°C max	$\tau$ s	DIMENSIONS	USE
S 8601 P	-50 +200	3,5s		
S 8601 PP	-50 +200	5s		
STS 3	-50 +150	3,5s		
STS 3/C	-50 +150	5s		
STS 3/P	-50 +150	5s		
TP 870	-50 +400	3s		
TP 870 C	-50 +400	5s		
TP 870 P	-50 +400	5s		
TP 870 A	-50 +250	12s		

Temperature











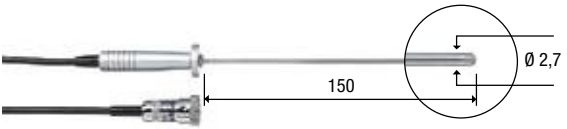

## Pt100 SENSOR PROBES FOR OBSOLETE INSTRUMENTS

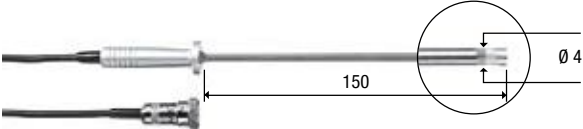
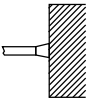
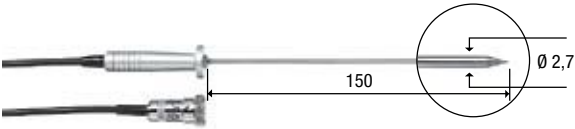
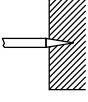
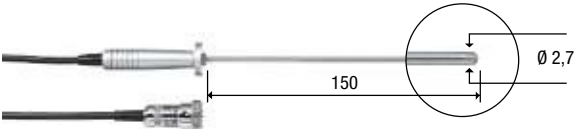
CODE	°C max	$\tau$ s	DIMENSIONS		USE
TP 871	-50 +200	3s			
TP 872/500	-50 +400	10s			
TP 872/1000					
TP 873	-50 +500	6s			
TP 874	-30 +200	3s			
TP 875.1	-30 +120	15s	<p>Globe-thermometer probe for measuring radiant heat <math>\varnothing</math>150 mm. (ISO7243, ISO7726). <b>4 wires</b> Pt100 sensor cable L=2m.</p>		
TP 876.1	-30 +120	15s	<p>Globe-thermometer probe for measuring radiant heat <math>\varnothing</math>50 mm. (ISO7243, ISO7726). <b>4 wires</b> Pt100 sensor cable L=2m.</p>		
TP 877	-200 +400	3s			
TP879.1	-20 +120	60s	<p>Penetration probe for compost 4 wires cable L = 2 m</p>		

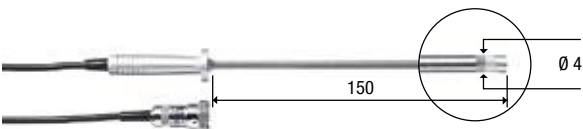
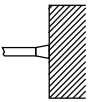
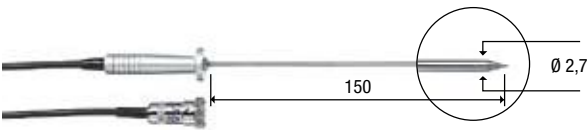
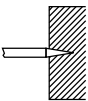
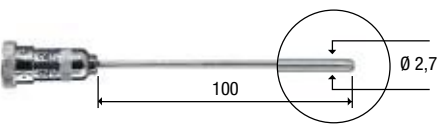

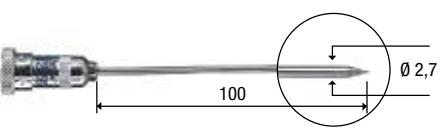
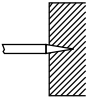
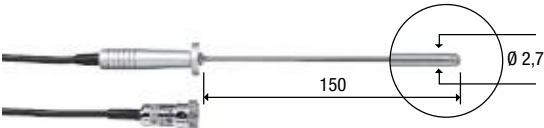
## Pt100 SENSOR PROBES FOR OBSOLETE INSTRUMENTS

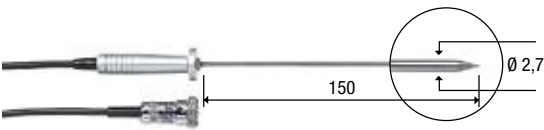
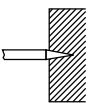
CODE	°C max	$\tau$ s		DIMENSIONS	USE
TP 9 A	-70 +400	3,5s	CLASS A		
TP 9 AC	-70 +400	5,5s	CLASS A		
TP 9 AP	-70 +400	4s	CLASS A		
TP 93	-70 +400	3,5s	CLASS 1/3 DIN		
TP 93 C	-70 +400	5,5s	CLASS 1/3 DIN		
TP 93 P	-70 +400	4s	CLASS 1/3 DIN		
TP 932	-70 +200	3,5s	CLASS 1/3 DIN		
TP 932 P	-70 +200	4s	CLASS 1/3 DIN		
TP 95	-70 +400	3,5s	CLASS 1/5 DIN		
TP 95 P	-70 +400	4s	CLASS 1/5 DIN		

Temperature

When temperature exceeds 400°C avoid violent impact and thermal shock, as the Pt100 sensor may get irreparably damaged.



**HD 2108.1, HD 2108.2, HD 2128.1, HD2128.2  
THERMOCOUPLE THERMOMETERS: K, J, T, N, R, S, B, E**

The HD2108.1 and HD2108.2 **with one input** and the HD2128.1 and HD2128.2 **with two inputs** are portable instruments with a large LCD display. They measure the temperature using immersion, penetration air or contact probes. The sensor may be a thermocouple of type K, J, T, N, R, S, B or E.

Instruments HD2108.2 and HD2128.2 are **data logger**, they store up to 76.000 samples the first and 38.000 couples of values the second. These data can be transferred into a PC connected to the instrument through a multi-standard RS232C serial port and a USB 2.0. It is possible to configure the storage interval, the printing and the baud rate by the menu.

All models are equipped with RS232C serial port and are able to transfer the acquired measures, in real time, into a PC or a portable printer.

Functions Max, Min and Avg calculate maximum, minimum and average values. Further functions are: REL relative measure, HOLD and automatic switching-off system, excludable. HD2128.1 and HD2128.2 calculate A-B difference of the temperatures acquired by the two input channels.

**Instruments have IP67 protection degree.**

	HD2108.1	HD2108.2	HD2128.1	HD2128.2
<b>TC input:</b>	1	1	2	2
<b>Storage capacity</b>	----	76000 samples	----	38000 couples of temperature
<b>PC interface</b>	RS232C	RS232C + USB2.0	RS232C	RS232C + USB2.0
<b>Data logger</b>	NO	YES	NO	YES
<b>A-B function</b>	NO	NO	YES	YES

**TECHNICAL SPECIFICATIONS OF THE INSTRUMENTS**

*Instrument*

Dimensions (Length x Width x Height) 185x90x40mm  
Weight 470g (complete with Batteries)  
Materials ABS, rubber  
Display 2x4½ digits plus symbols  
Visible area: 52x42mm

*Operating conditions*

Operating temperature -5 ... 50°C  
Storage temperature -25 ... 65°C  
Working relative humidity 0 ... 90% RH, no condensation

**Protection degree IP67**

*Power supply*

Batteries 4 Batteries 1.5V type AA  
Autonomy 200 hours with 1800mAh alkaline batteries  
Current consumption with instrument off 20µA  
Main 12Vdc / 1000mA Output main adapter

*Unit of measurement*

°C - °F - °K - mV - mV°C

*Security of data stored*

Unlimited, independent of battery charge conditions  
1min/month max drift

*Time*

Date and time Schedule in real time  
Accuracy 1min/month max drift

*Measured values storage*

Model **HD2108.2** 2000 pages each one containing 38 samples, 76000 samples in total

Model **HD2128.2** 2000 pages each one containing 19 samples, 38000 couples of samples

Storage interval 1s ... 3600s (1 hour)

*Serial interface RS232C*

Type RS232C electrically isolated  
Baud rate can be set from 1200 to 38400 baud  
Data bit 8  
Parity None  
Stop bit 1  
Flow Control Xon/Xoff  
Serial cable length Max 15m  
Immediate print interval 1s ... 3600s (1 hour)

*USB interface - model HD2108.2 and HD2128.2*

Type 1.1 - 2.0 electrically isolated

*Connections*

Probes input 2-pole female polarized standard miniature connector  
Serial interface and USB 8-pole MiniDin connector  
Mains adapter 2-pole connector (positive at centre)



### Measurement of temperature by Instrument

TC measuring range: K	-200...+1370°C
TC measuring range: J	-100...+750°C
TC measuring range: T	-200...+400°C
TC measuring range: N	-200...+1300°C
TC measuring range: R	+200...+1480°C
TC measuring range: S	+200...+1480°C
TC measuring range: B	+200...+1800°C
TC measuring range: E	-200...+750°C

**Resolution** **0.05°C up to 199.95°C**  
**0.1°C from 200.0°C up to full scale**

Instrument accuracy	
Thermocouple K	±0.1°C up to 600°C ±0.2°C over 600°C
Thermocouple J	±0.05°C up to 400°C ±0.1°C over 400°C
Thermocouple T	±0.1°C
Thermocouple N	±0.1°C up to 600°C ±0.2°C over 600°C
Thermocouple R	±0.25°C
Thermocouple S	±0.3°C
Thermocouple B	±0.35°C
Thermocouple E	±0.1°C up to 300°C ±0.15°C over 300°C

**Accuracy is referred to the instrument only; error due to the thermocouple or to the cold junction reference sensor is not included.**

Temperature drift @20°C	0.02%/°C
Drift after 1 year	0.1°C/year

### Thermocouple probes accuracy:

Tolerance of a type of thermocouple corresponds to the maximum acceptable shift from the e.m.f. of any thermocouple of that type, with reference junction at 0°C. The tolerance is expressed in degrees Celsius, preceded by the sign. The percentage tolerance is given by the ratio between the tolerance expressed in degrees Celsius and the measurement junction temperature, multiplied by one hundred.

The tolerances refer to the operating temperature expected for the thermocouple, in agreement with the thermo-elements' diameter.

Those thermocouples that comply with the limits for temperatures over 0°C, do not necessarily comply with the limits for ranges below 0°C.

### Tolerance classes for thermocouples (reference junction at 0°C)

Type of thermocouple	Tolerance Class 1	Tolerance Class 2	Tolerance Class 3 <sup>(1)</sup>
<b>Type T</b> Temperature interval Tolerance Temperature interval Tolerance	from -40 to +125°C ± 0.5°C from 125 to 350°C ± 0.004 · ltr	from -40 to +133°C ± 1°C from 133 to 350°C ± 0.0075 · ltr	from -67 to +40°C ± 1°C from -200 to -67°C ± 0.015 · ltr
<b>Type E</b> Temperature interval Tolerance Temperature interval Tolerance	from -40 to +375°C ± 1.5°C from 375 to 800°C ± 0.004 · ltr	from -40 to +333°C ± 2.5°C from 333 to 900°C ± 0.0075 · ltr	from -167 to +40°C ± 2.5°C from -200 to -167°C ± 0.015 · ltr
<b>Type J</b> Temperature interval Tolerance Temperature interval Tolerance	from -40 to +375°C ± 1.5°C from 375 to 750°C ± 0.004 · ltr	from -40 to +333°C ± 2.5°C from 333 to 750°C ± 0.0075 · ltr	- - - -
<b>Type K, type N</b> Temperature interval Tolerance Temperature interval Tolerance	from -40 to +375°C ± 1.5°C from 375 to 1000°C ± 0.004 · ltr	from 40 to +333°C ± 2.5°C from 333 to 1200°C ± 0.0075 · ltr	from -167 to +40°C ± 2.5°C from -200 to -167°C ± 0.015 · ltr
<b>Type R, type S</b> Temperature interval Tolerance Temperature interval Tolerance	from 0 to +1100°C ± 1°C from 1100 to 1600°C 1600°C ± [ 1 + 0.003 (t-1 100) ] °C	from 0 to +600°C ± 1.5°C from 600 to 1600°C ± 0.0025 · ltr	- - - -
<b>Type B</b> Temperature interval Tolerance Temperature interval Tolerance	- - - -	- - from 600 to 1700 °C ± 0.0025 · ltr	from +600 to +800°C + 4°C from 800 to 1700°C ± 0.005 · ltr

<sup>(1)</sup> Materials for thermocouples are generally supplied so to comply with the factory tolerances specified in the table for temperatures over -40°C. However these materials can sometimes not comply with the factory tolerances for the low temperatures reported under Class 3, for thermocouples of T, E, K and N type, when thermocouples have to comply at the same time the limits of Class 3 and Class 1 and/or Class 2.

### PURCHASING CODES

**HD2108.1:** The kit consists of **one input** instrument HD2108.1, 4 per 1.5V alkaline Batteries, instruction manual, case and DeltaLog9 software. **Probes and cables have to be ordered separately.**

**HD2108.2:** The kit consists of **one input** instrument HD2108.2, **data logger**, 4 per 1.5V alkaline Batteries, instruction manual, case and DeltaLog9 software. **Probes and cables have to be ordered separately.**

**HD2128.1:** The kit consists of **two inputs** instrument HD2128.1, 4 per 1.5V alkaline Batteries, instruction manual, case and DeltaLog9 software. **Probes and cables have to be ordered separately.**

**HD2128.2:** The kit consists of **two inputs** instrument HD2128.2, **data logger**, 4 per 1.5V alkaline Batteries, instruction manual, case and DeltaLog9 software. **Probes and cables have to be ordered separately.**

**HD2110CSNM:** 8-pole connection cable MiniDin - Sub D 9-pole female for RS232C.

**C.206:** Cable for instruments of the series HD21...1 and .2 to connect directly to USB input of PC.

**HD2101/USB:** Connection cable USB 2.0 connector type A - 8-pole MiniDin.

**DeltaLog9:** Software for download and management of the data on PC using Windows 98 to XP and Vista operating systems.

**SWD10:** Stabilized power supply at 230Vac/12Vdc-300mA-1000mA mains voltage.

**HD40.1:** Upon request, portable, serial input, 24 column thermal printers, 58mm paper width.

### Thermocouple probes

**Any thermocouple probe with standard miniature connector available on the price list can be connected to these instruments.**

**Please see pages from 17 to 21.**







## HD2328.0 TWO INPUTS THERMOCOUPLE THERMOMETER

**HD2328.0 with two inputs** is a portable instrument with a large LCD display. It measures temperature by means of immersion, penetration, contact or aria probes. Its sensor can be a K, J, T or E thermocouple type. Functions Max, Min and Avg calculate maximum, minimum and average values. Further functions are: REL relative measure, HOLD and automatic switching-off system. **The instrument has IP67 protection degree.**

### TECHNICAL SPECIFICATIONS OF THE INSTRUMENTS

#### Instrument

Dimensions (Length x Width x Height)	140x88x38mm
Weight	160g (complete with batteries)
Materials	ABS
Display	2x4½ digits plus symbols Visible area: 52x42mm

#### Operating conditions

Operating temperature	-5 ... 50°C
Storage temperature	-25 ... 65°C
Working relative humidity	0 ... 90% RH, no condensation
<b>Protection degree</b>	<b>IP67</b>

#### Power supply

Batteries	3 Batteries 1.5V type AA
Autonomy	200 hours with 1800mAh alkaline batteries
Current consumption with instrument off	< 20µA

#### Unit of measurement

°C - °F

#### Connections

Probes input	2 per 2-pole female polarized standard miniature connector
--------------	--

#### Temperature measure of the instrument

TC measuring range: K	-200...+1370°C
TC measuring range: J	-100...+750°C
TC measuring range: T	-200...+400°C
TC measuring range: E	-200...+750°C

#### Resolution **0.1°C**

Instrument accuracy	
Thermocouple K	±0.1°C up to 600°C ±0.2°C over 600°C
Thermocouple J	±0.1°C up to 400°C ±0.2°C over 400°C
Thermocouple T	±0.1°C
Thermocouple E	±0.1°C up to 300°C ±0.2°C over 300°C

**Accuracy is referred to the instrument only; error due to the thermocouple or to the cold junction reference sensor is not included.**

Temperature drift @20°C	0.02%/°C
Drift after 1 year	0.1°C/year

#### Thermocouple probes accuracy:

Tolerance of a type of thermocouple corresponds to the maximum acceptable shift from the e.m.f. of any thermocouple of that type, with reference junction at 0°C. The tolerance is expressed in degrees Celsius, preceded by the sign. The percentage tolerance is given by the ratio between the tolerance expressed in degrees Celsius and the measurement junction temperature, multiplied by one hundred.

The tolerances refer to the operating temperature expected for the thermocouple, in agreement with the thermo-elements' diameter.

Those thermocouples that comply with the limits for temperatures over 0°C, do not necessarily comply with the limits for ranges below 0°C.

#### Tolerance classes for thermocouples (reference junction at 0°C)

Type of thermocouple	Tolerance Class 1	Tolerance Class 2	Tolerance Class 3 <sup>(1)</sup>
<b>Type T</b>			
Temperature interval	from -40 to +125°C	from -40 to +133°C	from -67 to +40°C
Tolerance	± 0.5°C	± 1°C	± 1°C
Temperature interval	from 125 to 350°C	from 133 to 350°C	from -200 to -67°C
Tolerance	± 0.004 · ttr	± 0.0075 · ttr	± 0.015 · ttr
<b>Type E</b>			
Temperature interval	from -40 to +375°C	from -40 to +333°C	from -167 to +40°C
Tolerance	± 1.5°C	± 2.5°C	± 2.5°C
Temperature interval	from 375 to 800°C	from 333 to 900°C	from -200 to -167°C
Tolerance	± 0.004 · ttr	± 0.0075 · ttr	± 0.015 · ttr
<b>Type J</b>			
Temperature interval	from -40 to +375°C	from -40 to +333°C	-
Tolerance	± 1.5°C	± 2.5°C	-
Temperature interval	from 375 to 750°C	from 333 to 750°C	-
Tolerance	± 0.004 · ttr	± 0.0075 · ttr	-
<b>Type K, type N</b>			
Temperature interval	from -40 to +375°C	from 40 to +333°C	from -167 to +40°C
Tolerance	± 1.5°C	± 2.5°C	± 2.5°C
Temperature interval	from 375 to 1000°C	from 333 to 1200°C	from -200 to -167°C
Tolerance	± 0.004 · ttr	± 0.0075 · ttr	± 0.015 · ttr

<sup>(1)</sup> Materials for thermocouples are generally supplied so to comply with the factory tolerances specified in the table for temperatures over -40°C. However these materials can sometimes not comply with the factory tolerances for the low temperatures reported under Class 3, for thermocouples of T, E, K and N type, when thermocouples have to comply at the same time the limits of Class 3 and Class 1 and/or Class 2.

#### PURCHASING CODES

**HD2328.0:** The kit consists of **two inputs** instrument HD2328.0, 3 per 1.5V alkaline Batteries, instruction manual, case. **Probes have to be ordered separately.**

#### Thermocouple probes





**Any thermocouple probe with standard miniature connector available on the price list can be connected to these instruments.**

**Please see pages from 17 to 21.**

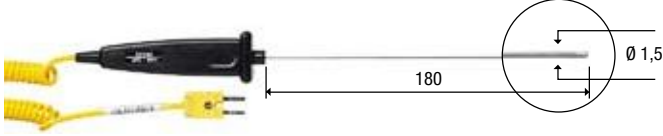
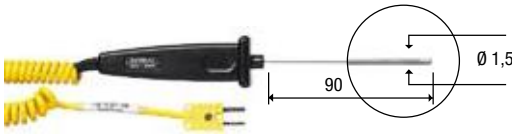
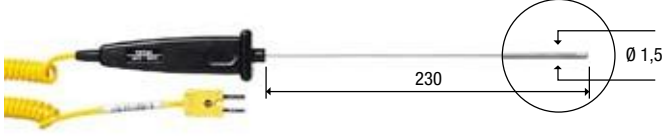
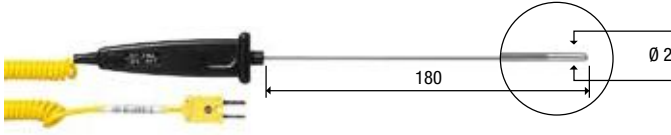
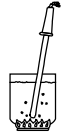

# THERMOCOUPLE PROBES FOR PORTABLE INSTRUMENTS

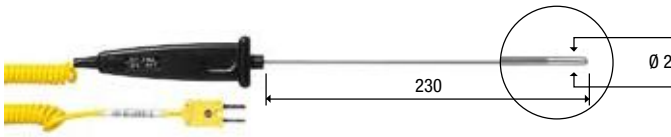
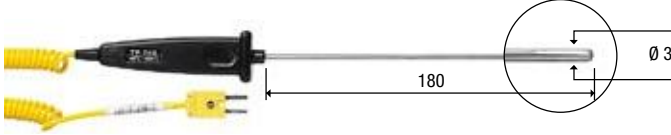
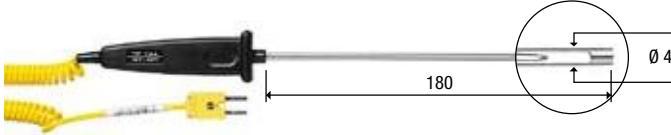
## TYPE "K" (CHROMEL - ALUMEL) THERMOCOUPLE PROBES

CODE	°C max	$\tau$ s	DIMENSIONS	USE
TP 741	800	2s		
TP 741/1	400	2s		
TP 741/2	800	2s		
TP 742	800	2s		
TP 742/1	400	2s		
TP 742/2	800	2s		
TP 743	800	3s		
TP 744	400	4s		











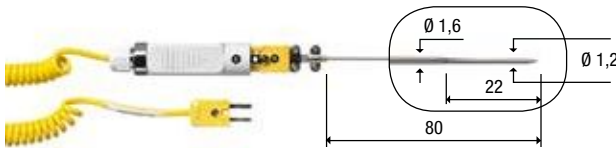

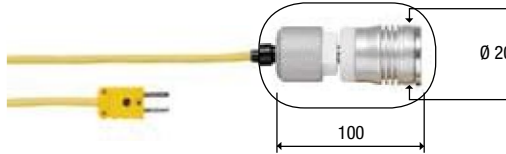



Temperature

## TYPE "K" (CHROMEL - ALUMEL) THERMOCOUPLE PROBES

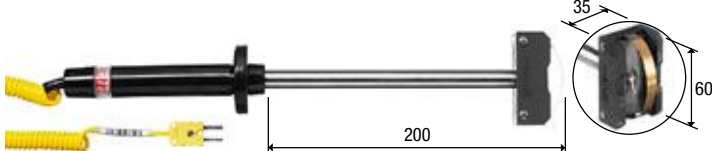
CODE	°C max	$\tau$ s	DIMENSIONS	USE
TP 745	500	5s		
TP 746	250	2s		
TP 750	1000	3s		
TP 750.0	800	3s		
TP 751	200	2s		
TP 754	500	2s		
TP 754/9	500	2s		
TP 755	800	2s		
TP 755/9	800	2s		

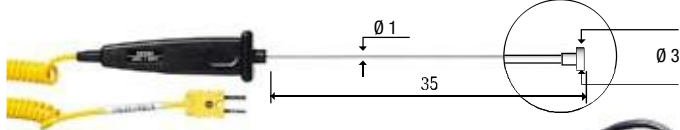

## TYPE "K" (CHROMEL - ALUMEL) THERMOCOUPLE PROBES

CODE	°C max	$\tau$ s	DIMENSIONS	USE
TP 756	200	2s		
TP 757	180	30s	MAGNETIC PROBE FOR CONTACT MEASURE ON MAGNETIC METALLIC SURFACES 	
TP 758	400	4s		
TP 758.1	400	4s		
TP 772	400	3s		
TP 774	250	2s		
TP 776	200	2s		
TP 777	200	3s		

Temperature



## TYPE "K" (CHROMEL - ALUMEL) THERMOCOUPLE PROBES

CODE	°C max	$\tau$ s	DIMENSIONS	USE
TP 647	300	2s	<p style="text-align: center;">For SIT calibration up to 300°C.</p>	
TP 647/2	300	2s		
TP 647/3	300	2s		
TP 647/5	300	2s		
TP 651	1200	6s		
TP 652	1200	6s		
TP 655	180	2s		
TP 656	200	1s		
TP 656/1	1000	1s		
TP 656/2	1000	1s		
TP 657/1	100	5s		
TP 658	100	2s		

## TYPE "K" (CHROMEL - ALUMEL) THERMOCOUPLE PROBES

CODE	°C max	$\tau$ s	DIMENSIONS	USE
TP 659	400	3s		
TP 660	400	4s		
TP 661	-60 +50	30s		
TP 662	110	120s	PROBE WITH VELCRO TAPE FOR MEASURES ON PIPES MAX 110 DIAM. 	
CM CS	"K" "K"			
PW	"K"			

Temperature

### Response time for a 63% variation ( $\tau_{0.63}$ )

Response time  $\tau$  s is the reaction time of the sensor to a temperature variation, with a variation of the measured signal to a given percentage (63%) of the variation.

Response times are referred to:

Immersion probes when into water at 100°C.

Contact probes when in contact with a metallic surface at 200°C.

Air probes at air temperature of 100°C.





## HD2178.1 AND HD2178.2 Pt100 AND TC INPUT THERMOMETERS

**HD2178.1 and HD2178.2** are portable instruments with a large LCD display. These instruments measure temperature by means of immersion, penetration, contact or air probes with Pt100 or thermocouple probes. You can connect a 3 or 4 wires Pt100 sensor or a 2 wires Pt1000 sensor to B input, a K, J, T, N, E type thermocouple to input A. Probes to B input, a 8-poles DIN45326 connector, are equipped with an automatic detection module, with the factory calibration settings already being memorized inside. A input is equipped with a miniature female polarized connector for thermocouple probes. The instrument HD2178.2 is a **data logger**; it stores up to 80.000 samples that can be transferred to a PC when connected to the instrument through a multi-standard RS232C serial port and a USB 2.0 port. It is possible to configure the storage interval, the printing and the baud rate by the menu. HD2178.1 and HD2178.2 are equipped with RS232C serial port and are able to transfer the acquired measures, in real time, into a PC or a portable printer. Functions Max, Min and Avg calculate maximum, minimum and average values. Further functions are: REL relative measure, HOLD and automatic switching-off system, excludable. **Instruments have IP67 protection degree.**

### TECHNICAL SPECIFICATIONS OF THE INSTRUMENTS

#### Instrument

Dimensions (Length x Width x Height)	185x90x40mm
Weight	470g (complete with Batteries)
Materials	ABS, rubber
Display	2x4½ digits plus symbols Visible area: 52x42mm

#### Operating conditions

Operating temperature	-5 ... 50°C
Storage temperature	-25 ... 65°C
Working relative humidity	0 ... 90% RH, no condensation
<b>Protection degree</b>	<b>IP67</b>

#### Power supply

Batteries	4 Batteries 1.5V type AA
Autonomy	200 hours with 1800mAh alkaline batteries
Current consumption with instrument off	20µA
Main	12Vdc / 1000mA Output main adapter

Unit of measurement	°C - °F
Security of data stored	Unlimited, independent of battery charge conditions 1min/month max drift

#### Time

Date and time	Schedule in real time
Accuracy	1min/month max drift

#### Measured values storage - model **HD2178.2**

Type	2000 pages each one containing 40 samples
Quantity	80000 samples in total
Storage interval	1s ... 3600s (1 hour)

#### Serial interface RS232C

Type	RS232C electrically isolated can be set from 1200 to 38400 baud
Baud rate	8
Data bit	None
Parity	1
Stop bit	Xon/Xoff
Flow Control	Max 15m
Serial cable length	1s ... 3600s (1 hour)
Immediate print interval	

#### USB interface - model **HD2178.2**

Type	1.1 - 2.0 electrically isolated
------	---------------------------------

#### Connections

Input for probes	8 pole male DIN45326 connector
Serial and USB interface	8-pole MiniDin connector
Mains adapter	2-pole connector (positive at centre)

#### Temperature measurement by instrument - **RTD sensors**

Pt100 Measuring range	-200...+650°C
Pt1000 Measuring range	-200...+650°C
Resolution	0.1°C
Accuracy	±0.05°C
Drift after 1 year	0.1°C/year

#### Temperature measurement by instrument - **Tc**

TC measuring range: K	-200...+1370°C
TC measuring range: J	-100...+750°C
TC measuring range: T	-200...+400°C
TC measuring range: N	-200...+1300°C
TC measuring range: E	-200...+750°C

Resolution	0.1°C
Instrument accuracy	
Thermocouple K	±0.1°C up to 600°C ±0.2°C over 600°C
Thermocouple J	±0.05°C up to 400°C ±0.1°C over 400°C
Thermocouple T	±0.1°C
Thermocouple N	±0.1°C up to 600°C ±0.2°C over 600°C
Thermocouple E	±0.1°C up to 300°C
±0.15°C over 300°C	

**Accuracy is referred to the instrument only; error due to the thermocouple or to the cold junction reference sensor is not included.**

Temperature drift @20°C	0.02%/°C
Drift after 1 year	0.1°C/year

#### Thermocouple probes accuracy:

Tolerance of a type of thermocouple corresponds to the maximum acceptable shift from the e.m.f. of any thermocouple of that type, with reference junction at 0°C. The tolerance is expressed in degrees Celsius, preceded by the sign. The percentage tolerance is given by the ratio between the tolerance expressed in degrees Celsius and the measurement junction temperature, multiplied by one hundred. The tolerances refer to the operating temperature expected for the thermocouple, in agreement with the thermo-elements' diameter. Those thermocouples that comply with the limits for temperatures over 0°C, do not necessarily comply with the limits for ranges below 0°C.



**Tolerance classes for thermocouples (reference junction at 0°C)**

Type of thermocouple	Tolerance Class 1	Tolerance Class 2	Tolerance Class 3 <sup>(1)</sup>
<b>Type T</b> Temperature interval Tolerance Temperature interval Tolerance	from -40 to +125°C ± 0.5°C from 125 to 350°C ± 0.004 · ltr	from -40 to +133°C ± 1°C from 133 to 350°C ± 0.0075 · ltr	from -67 to +40°C ± 1°C from -200 to -67°C ± 0.015 · ltr
<b>Type E</b> Temperature interval Tolerance Temperature interval Tolerance	from -40 to +375°C ± 1.5°C from 375 to 800°C ± 0.004 · ltr	from -40 to +333°C ± 2.5°C from 333 to 900°C ± 0.0075 · ltr	from -167 to +40°C ± 2.5°C from -200 to -167°C ± 0.015 · ltr
<b>Type J</b> Temperature interval Tolerance Temperature interval Tolerance	from -40 to +375°C ± 1.5°C from 375 to 750°C ± 0.004 · ltr	from -40 to +333°C ± 2.5°C from 333 to 750°C ± 0.0075 · ltr	- - - -
<b>Type K, type N</b> Temperature interval Tolerance Temperature interval Tolerance	from -40 to +375°C ± 1.5°C from 375 to 1000°C ± 0.004 · ltr	from 40 to +333°C ± 2.5°C from 333 to 1200°C ± 0.0075 · ltr	from -167 to +40°C ± 2.5°C from -200 to -167°C ± 0.015 · ltr
<b>Type R, type S</b> Temperature interval Tolerance Temperature interval Tolerance	from 0 to +1100°C ± 1°C from 1100 to 1600°C ± [ 1 + 0.003 (t-100) ] °C	from 0 to +600°C ± 1.5°C from 600 to 1600°C ± 0.0025 · ltr	- - - -
<b>Type B</b> Temperature interval Tolerance Temperature interval Tolerance	- - - -	- - from 600 to 1700 °C ± 0.0025 · ltr	from +600 to +800°C + 4°C from 800 to 1700°C ± 0.005 · ltr

<sup>(1)</sup> Materials for thermocouples are generally supplied so to comply with the factory tolerances specified in the table for temperatures over -40°C. However these materials can sometimes not comply with the factory tolerances for the low temperatures reported under Class 3, for thermocouples of T, E, K and N type, when thermocouples have to comply at the same time the limits of Class 3 and Class 1 and/or Class 2.

**TECHNICAL DATA OF PROBES AND MODULES EQUIPPED WITH INSTRUMENT**  
**Temperature probes Pt100 sensor with SICRAM module**

Model	Type	Application field	Accuracy
TP472I	Immersion	-196°C...+500°C	±0.25°C (-196°C...+350°C) ±0.4°C (+350°C...+500°C)
TP472I.0	Immersion	-50°C...+400°C	±0.25°C (-50°C...+350°C) ±0.4°C (+350°C...+400°C)
TP473P	Penetration	-50°C...+400°C	±0.25°C (-50°C...+350°C) ±0.4°C (+350°C...+400°C)
TP473P.0	Penetration	-50°C...+400°C	±0.25°C (-50°C...+350°C) ±0.4°C (+350°C...+400°C)
TP474C	Contact	-50°C...+400°C	±0.3°C (-50°C...+350°C) ±0.4°C (+350°C...+400°C)
TP474C.0	Contact	-50°C...+400°C	±0.3°C (-50°C...+350°C) ±0.4°C (+350°C...+400°C)
TP475A.0	Air	-50°C...+250°C	±0.3°C (-50°C...+250°C)
TP472I.5	Immersion	-50°C...+400°C	±0.3°C (-50°C...+350°C) ±0.4°C (+350°C...+400°C)
TP472I.10	Immersion	-50°C...+400°C	±0.30°C (-50°C...+350°C) ±0.4°C (+350°C...+400°C)
TP49A	Immersion	-70°C...+400°C	±0.25°C (-50°C...+350°C) ±0.4°C (+350°C...+400°C)
TP49AC	Contact	-70°C...+400°C	±0.25°C (-50°C...+350°C) ±0.4°C (+350°C...+400°C)
TP49AP	Penetration	-70°C...+400°C	±0.25°C (-50°C...+350°C) ±0.4°C (+350°C...+400°C)
TP875	Globe-thermometer Ø150mm	-30°C...+120°C	±0.25°C
TP876	Globe-thermometer Ø 50mm	-30°C...+120°C	±0.25°C
TP87	Immersion	-50°C...+200°C	±0.25°C
TP878 TP878.1	For solar panels	+5°C...+80°C	±0.25°C
TP879	For compost	-20°C...+120°C	±0.25°C

**Common features**

Temperature drift @20°C 0.003%/°C

**4 wires Pt100 and 2 wires Pt1000 Probes**

Model	Type	Application field	Accuracy
TP47.100	4 wires Pt100	-50...+400°C	Class A
TP47.1000	2 wires Pt1000	-50...+400°C	Class A

**Common features**

Temperature drift @20°C

Pt100 0.003%/°C  
Pt1000 0.005%/°C

**PURCHASING CODES**

**HD2178.1:** The kit consists of instrument HD2178.1, 4 per 1.5V alkaline Batteries, instruction manual and case, software DeltaLog9. **Probes and cables have to be ordered separately**

**HD2178.2:** The kit consists of instrument **data logger** HD2178.2, 4 per 1.5V alkaline Batteries, instruction manual and case, software DeltaLog9. **Probes and cables have to be ordered separately**

**HD2110CSNM:** 8-pole connection cable MiniDin - Sub D 9-pole female for RS232C.

**C.206:** Cable for instruments of the series HD21...1 and .2 to connect directly to USB input of PC.

**HD2101/USB:** Connection cable USB 2.0 connector type A - 8-pole MiniDin.

**DeltaLog9:** Software for download and management of the data on PC using Windows 98 to XP and Vista operating systems.

**SWD10:** Stabilized power supply at 230Vac/12Vdc-300mA-1000mA mains voltage.

**HD40.1:** Upon request, portable, serial input, 24 column thermal printer, 58mm paper width.

**Probes equipped with SICRAM module**

**TP472I:** Immersion probe, Pt100sensor. Stem Ø 3 mm, length 300 mm. Cable 2 meters long.

**TP472I.0:** Immersion probe, Pt100sensor. Stem Ø 3 mm, length 230 mm. Cable 2 meters long.

**TP473P:** Penetration probe, Pt100sensor. Stem Ø 4mm, length 150 mm. Cable 2 meters long.

**TP473P.0:** Penetration probe, Pt100sensor. Stem Ø 4mm, length 150 mm. Cable 2 meters long.

**TP474C:** Contact probe, Pt100sensor. Stem Ø 4mm, length 230mm, contact surface Ø 5mm. Cable 2 meters long.

**TP474C.0:** Contact probe, Pt100sensor. Stem Ø 4mm, length 230mm, contact surface Ø 5mm. Cable 2 meters long.

**TP475A.0:** Air probe, Pt100sensor. Stem Ø 4mm, length 230mm. Cable 2 meters long.

**TP472I.5:** Immersion probe, Pt100sensor. Stem Ø 6mm, length 500 mm. Cable 2 meters long.

**TP472I.10:** Immersion probe, Pt100sensor. Stem Ø 6mm, length 1,000mm. Cable 2 meters long.

**TP49A:** Immersion probe, Pt100sensor. Stem Ø 2.7mm, length 150mm. Cable 2 meters long. Aluminium handle.

**TP49AC:** Contact probe, Pt100sensor. Stem Ø 4 mm, length 150mm. Cable 2 meters long. Aluminium handle.

**TP49AP:** Penetration probe, Pt100sensor. Stem Ø 2.7mm, length 150mm. Cable 2 meters long. Aluminium handle.

**TP875:** Globe thermometer Ø 150 mm with handle. Cable 2 meters long.

**TP876:** Globe thermometer Ø 50 mm with handle. Cable 2 meters long.

**TP87:** Immersion probe, Pt100sensor. Stem Ø 3 mm, length 70 mm. Cable 2 meters long.

**TP878:** Contact probe for solar panels. Cable 2 meters long.

**TP878.1:** Contact probe for solar panels. Cable 5 meters long

**TP879:** Penetration probe for compost. Stem Ø 8 mm, length 1 meter. Cable 2 meters long.

**Temperature probes without SICRAM module**

**TP47.100:** Direct 4 wires Pt100 sensor immersion probe. Stem Ø 3 mm, length 230mm. 4 wires connection cable with connector, 2 meters long.

**TP47.1000:** Pt1000 sensor immersion probe. Stem Ø 3 mm, length 230mm. 2 wires connection cable with connector, 2 meters long.

**TP47:** Only connector for probe connection: direct 3 and 4 wires Pt100, 2 wires Pt1000.

**Thermocouple probes**

**Any thermocouple probe with standard miniature connector available on the price list can be connected to these instruments.**

**Please see pages from 17 to 21.**



Temperature





**HD32.7 - HD32.8.8 - HD32.8.16  
DATALOGGER**

**HD32.7  
8 INPUTS DATA LOGGER FOR PT100 SENSOR PROBES**

The instrument HD32.7 is a robust 8 inputs data logger for Pt100 sensor temperature probes equipped with SICRAM module. 4 wires Pt100 Probe.

- Unit of measurement °C, °F, °K configurable.
- Flash memory organized in 64 sections with a total capacity of 96.000 acquisitions for each one of the 8 inputs. Storage can be managed in two ways:
  - when the available memory is full, data are overwritten by starting from the oldest ones (circular memory),
  - storage stops when the available memory is full.
- Simultaneous display of the 8 inputs.
- Maximum, minimum or average of the stored values.
- Selectable storage interval: 2, 5, 10, 15, 30 seconds, 1, 2, 5, 10, 15, 20, 30 minutes and 1 hour.
- Data logging: instantaneous or postponed, with the possibility of selecting the storage start and end.
- Data download: RS232C, 1200...38400 baud or USB 1.1 – 2.0.
- DeltaLog9 software for data download and processing.
- LCD backlit graphic display 128x64 pixel.
- Instrument setup through the keyboard; no connection required to the PC.
- Security password for keyboard locking.
- Power supply: 4 1.5V alkaline C-BABY type batteries or external power supply 12VDC-1A.
- Consumption @6VDC:
  - <60µA when the instrument is off
  - <60µA in sleep mode with 8 probes connected
  - <40mA during data logging with 8 probes connected
- Use of the HD32.7 data logger: in the field for machine or equipment measurements, plant or machine testing, production check, oven mapping.

**TECHNICAL SPECIFICATIONS**

<i>Number of Inputs</i>	8 DIN 45326 8-poles male connectors.
<i>Instrument accuracy when storing</i>	±0.01°C ±1digit (in the range ±199.99°C) ±0.1°C ±1digit in the remaining range
<i>Internal watch accuracy</i>	1 min/month max drift
<i>Unit of measurement</i>	°C, °F, °K
<i>Resolution</i>	0.01°C (in the range ±199.99°C) 0.1°C in the remaining range
<i>Measuring range</i>	-200°C ... 650°C
<i>Display</i>	Backlit graphic LCD 128x64 pixel.
<i>Keyboard</i>	15 keys, configurable also without PC.
<i>Keyboard locking function</i>	with password.
<i>Memory</i>	divided into 64 blocks.
<i>Memory capacity</i>	96.000 storages for each one of the inputs.
<i>Security of data stored</i>	unlimited
<i>Power supply</i>	4 per 1.5V alkaline Batteries type C-BABY External 12Vdc-1A power supply. Connector, external Ø 5.5mm, internal Ø 2.1mm.
<i>Current consumption @6Vdc</i>	<60µA when the instrument is off <60µA in sleep mode with 8 probes connected <40mA during data logging with 8 probes connected

<i>Autonomy</i>	200 hours with 7800mAh alkaline batteries and 8 probes connected
-----------------	--

<i>Data download</i>	RS232C from 1200 to 38400 baud, galvanically isolated. Sub D 9-pole male connector. USB 1.1 – 2.0 galvanically isolated.
----------------------	--



⊙ 12 Vdc 1A    □ USB 1.1 - 2.0    ○ RS232C





### Operating conditions

Operating temperature	-5 ... 50°C
Storage temperature	-25 ... 65°C
Working relative humidity	0 ... 90% RH no condensation
Protection degree	IP64

### Instrument

Dimensions	
(Length x Width x Height)	220x180x50 mm
Weight	1100 g (complete with batteries)
Materials	ABS, polycarbonate and aluminium

### Probes

**all Delta Ohm Pt100 probes equipped with SICRAM module belonging to the series TP47..., TP49..., TP87 and 4 wires Pt100 sensor probes can be connected. Please see pages 9 and 10.**  
Probes of different form can be supplied upon request.

### PURCHASING CODES

**HD32.7:** Instrument **Data logger** with **8 inputs** for temperature Pt100 sensor probes equipped with SICRAM module and 4 wires Pt100 probes. The kit consists of instrument HD32.7, 4 per 1.5Vdc alkaline C-Baby type Batteries, instruction manual, software DeltaLog9 and support and carrying strap. **Probes, tripod, carrying case and cables have to be ordered separately.**

**DeltaLog9:** Further copy of the software for download and management of data by PC for Windows from 98 to Vista operating systems.

### PROBES FOR HD32.7

All temperature Pt100 probes equipped with SICRAM module and 4 wires Pt100 sensor probes can be connected to the instrument. **Probes of different form can be supplied upon request.**

### ACCESSORIES FOR HD32.7

**9CPRS232:** Connection cable with Sub D 9-pole female connectors for RS232C (null modem)

**CP22:** Connection cable USB 2.0 connector type A - connector type B.

**BAG32.2:** Carrying case for the HD32.7 instrument and accessories.

**HD32CS:** Support and carrying strap

**SWD10:** 100-240VAC/12VDC-1A stabilized mains power supply

**VTRAP32:** Tripod complete with 6-input head and 5 probe holders code HD3218K

**HD3218K:** Shaft for another probe

### HD32.8.8

#### 8 INPUTS DATA LOGGER FOR PT100 SENSOR PROBES

### HD32.8.16

#### 16 INPUTS DATA LOGGER FOR THERMOCOUPLES

Instruments **HD32.8.8** and **HD32.8.16** are two robust data loggers with 8 inputs the first, 16 inputs the second, for K, J, T, N, R, S, B and E type thermocouple with miniature connector temperature probes.

- Unit of measurement °C, °F, °K configurable.
- Flash memory organized in 64 sections with a total capacity of 800.000 acquisitions to be divided among all the present inputs. Storage can be managed in two ways:
  - when the available memory is full, data are overwritten by starting from the oldest ones (circular memory),
  - storage stops when the available memory is full
- Simultaneous display of the 8 inputs.
- Maximum, minimum or average of the stored values.
- Selectable storage interval: 2, 5, 10, 15, 30 seconds, 1, 2, 5, 10, 15, 20, 30 minutes and 1 hour.
- Data logging: instantaneous or postponed, with the possibility of selecting the storage start and end.
- Data download: RS232C, 1200...38400 baud or USB 1.1 – 2.0.
- DeltaLog9 software for data download and processing.
- LCD backlit graphic display 128x64 pixel.
- Instrument setup through the keyboard; no connection required to the PC.
- Security password for keyboard locking.
- Power supply: 4 1.5V alkaline C-BABY type batteries, or external power supply 12VDC-1A or by means of the USB port of the PC.
- Consumption @6VDC:
  - <60µA when the instrument is off
  - <60µA in sleep mode with 8 probes connected
  - <40mA during data logging with 8 probes connected
- Use of data loggers HD32.8.8 and HD32.8.16: in field for measurement campaigns on complex systems with many measurement points, testing facilities, in pharmaceutical and food sectors, ovens mapping, air conditioning centrals etc.

### TECHNICAL SPECIFICATIONS

#### Number of inputs

8 for HD32.8.8
16 for HD32.8.16

#### Connection

Miniature female socket for thermocouple

#### Measuring range and accuracy of the instrument

Tc: K	-200...+1370°C / ±0.1°C up to 600°C ±0.2°C over 600°C
Tc: J	-100...+750°C / ±0.1°C up to 400°C ±0.2°C over 400°C
Tc: T	-200...+400°C / ±0.1°C
Tc: N	-200...+1300°C / ±0.1°C up to 600°C ±0.2°C over 600°C
Tc: R	+200...+1480°C / ±0.3°C
Tc: S	+200...+1480°C / ±0.3°C
Tc: B	+200...+1800°C / ±0.4°C
Tc: E	-200...+750°C / ±0.1°C up to 300°C ±0.2°C over 300°C

**Accuracy is referred to the instrument only; error due to the thermocouple or to the cold junction reference sensor is not included.**

#### Resolution

0.05°C in the range ±199.95°C
0.1°C in the remaining range

#### Drift in temperature @20°C

0.02%/°C

#### Drift after 1 year

0.1°C/year

#### Internal watch accuracy

1 min/month max drift

#### Unit of measurement

°C, °F, °K

#### Display

LCD backlit graphic display 128x64 pixel.

#### Keyboard

15 keys; the instruments can be configured also without a PC.



HD 32.8.16



HD 32.8.8



#### Keyboard locking function

with password.

#### Memory

##### Memory capacity

divided into 64 blocks  
up to 800.000 acquisitions to be divided among all the present inputs. For example, when one probe is connected you get 800.000 acquisitions. When 8 probes are connected you get 96.000 acquisitions each probe.

##### Security of data stored

Unlimited.

##### Power supply

4 per 1.5V 4 1.5V alkaline C-BABY type batteries  
External power supply 12VDC-1A. Connector, external  $\varnothing$  5.5mm, internal  $\varnothing$  2.1mm.  
Power supply via the PC USB port.

##### Current consumption @6Vdc

<60 $\mu$ A when the instrument is off  
<60 $\mu$ A in sleep mode with all probes connected  
<40mA during data logging with all probes connected

##### Autonomy

200 hours with 7800mAh alkaline batteries and all probes connected

##### Data download

RS232C from 1200 to 38400 baud, galvanically isolated. Sub D 9-pole male connector.  
USB 1.1 – 2.0 galvanically isolated.

##### Operating conditions

Operating temperature -5 ... 50°C  
Storage temperature -25 ... 65°C  
Working relative humidity 0 ... 90% RH no condensation  
Protection degree IP64

##### Instrument

Dimensions 220x180x50 mm  
(Length x Width x Height)  
Weight 1100 g (complete with batteries)  
Materials ABS, polycarbonate and aluminium

##### Probes

**All thermocouples K, J, T, N, R, S, B and E type probes with male miniature connector can be connected.**

Further to the K probes available on the catalogue from page 17 to 21, Delta Ohm can supply other kind of probes with different forms as well, upon request.

#### PURCHASING CODES

**HD32.8.8:** Instrument **Data logger with 8 inputs** for thermocouples K, J, T, N, R, S, B and E type temperature probes. The kit consists of instrument HD32.8.8, 4 per 1.5Vdc alkaline C-Baby type Batteries, instruction manual, software DeltaLog9 and support and carrying strap. **Probes, tripod, carrying case and cables have to be ordered separately.**

**HD32.8.16:** Instrument **Data logger with 16 inputs** for thermocouples K, J, T, N, R, S, B and E type temperature probes. The kit consists of instrument HD32.8.8, 4 per 1.5Vdc alkaline C-Baby type Batteries, instruction manual, software DeltaLog9 and support and carrying strap. **Probes, tripod, carrying case and cables have to be ordered separately**

**DeltaLog9:** Further copy of the software for download and management of data by PC for Windows from 98 to Vista operating systems.

#### Probes for HD32.8.8 and for HD32.8.16

All thermocouples K, J, T, N, R, S, B and E type temperature probes with miniature standard connector can be connected to the instruments.

**Probes of different form can be supplied upon request.**

#### Accessories for HD32.8.8 and for HD32.8.16

**9CPRS232:** Connection cable with Sub D 9-pole female connectors for RS232C (null modem)

**CP22:** Connection cable USB 2.0 connector type A - connector type B.

**BAG32.2:** Carrying case for the HD32.7 instrument and accessories.

**HD32CS:** Support and carrying strap

**SWD10:** 100-240VAC/12VDC-1A stabilized mains power supply

**VTRAP32:** Tripod complete with 6-input head and 5 probe holders code HD3218K

**HD3218K:** Shaft for another probe





### 4÷20 mA CONFIGURABLE TEMPERATURE TRANSMITTERS FOR Pt100 SENSORS

HD 788TR1, HD 788TR1-I, HD 786TR1, HD 988TR1, HD 988TR1-I and HD 988TR2 are 4÷20 mA configurable transmitters with microprocessor for Pt100 Platinum temperature sensor. They convert the temperature variations found with any standard Pt100 sensor (100Ω at 0°C) into a linear current signal with two leads in the field 4÷20 mA. Linearization with a digital technique allows excellent precision and stability to be obtained. User can set the 4÷20 mA output (or 20÷4 mA) in any temperature range within the field -200...+650°C, with a minimum amplitude of 25°C; it may be simply reprogrammed by pressing a key, without any need to regulate jumpers, potentiometers, software, etc. A led indicates any alarm situations (temperature outside the set range, broken or short-circuiting sensor) and assists the user in the programming phase. **The 4÷20mA output of models HD788TR1-I and HD988TR1-I is galvanically isolated from the Pt100 input.** The transmitters are also protected against inversions of polarity. The HD 788TR1, HD 788TR1-I are specifically designed for installing in type DIN B connecting heads, while the HD 988TR1, HD988TR1-I and HD 988TR2 are suitable for fitting in containers with a 35 mm DIN bar connection. As well as the 4÷20 mA output, the HD 988TR2 has a

°C	Ω	°C	Ω	°C	Ω
-200	18.52	70	127.08	200	175.86
-100	60.26	80	130.90	220	183.19
-50	80.31	90	134.71	250	194.10
-30	88.22	100	138.51	280	204.90
-20	92.16	110	142.29	300	212.05
-10	96.09	120	146.07	350	229.72
0	100.00	130	149.83	400	247.09
10	103.90	140	153.58	450	264.18
20	107.79	150	157.33	500	280.98
30	111.67	160	161.05	550	297.49
40	115.54	170	164.77	600	313.71
50	119.40	180	168.48	650	329.64
60	123.24	190	172.17		

Tab. 1

convenient 3 digit display (height 10 mm) which allows the display of the measured temperature.

#### Technical data (20°C and 24VDC)

INPUT	HD 788TR1 HD 788TR1-I HD 786TR1 HD 988TR1 HD 988TR1-I	HD 988TR2
Sensor	Pt100 (100Ω at 0°C)	
Connection	3 (or 2) wires	
Linearization	EN 60751, IEC 751 BS 1904 (α=0,00385)	
Current into sensor	<1 mA	
Measuring range	-200...+650°C	
Default range	0...100°C	
Minimum measuring amplitude	25°C	
Influence of the connecting leads	Negligible with coupled lead	
Conversion speed	2 measurements per second	
Accuracy	±0,1°C ±0,1% of the reading (-100...+500°C) ±0,2°C ±0,2% of the reading (-200...+650°C)	
Sensibility to variations of env. temperature	0,01°C/°C	
Working temperature	0...70°C	
Storage temperature	-40...+80°C	
<b>OUTPUT</b>		
Output	4...20 mA (or 20...4 mA) 22 mA in case of incorrect programming or temperature out of range note 1 and Fig. 2	
Resolution	4 μA	Analogue output: 4 μA Display: 0,1°C up to 200°C 1°C over 200°C
Power supply voltage	7...30Vdc (protection against inversions of polarity)	
Sensibility to variations of the feeding voltage Vcc	0,4 μA/V	
Load resistance	$R_{LMax} = \frac{Vdc-9}{0,022} \Rightarrow R_{LMax} = 680 \Omega @ Vdc = 24 Vdc$	
Red led	It switches on while programming and when the measured temperature is out of the set range	
Input-Output isolation for models HD 788TR1-I and HD 988TR1-I	500 Vdc	-

Temperature

**Note 1) If the measured temperature T is out of the set range T1...T2 (T1<T2), HD 788TR1, HD 788TR1-I, HD 988TR1, HD 988TR1-I and HD 988TR2 maintain 4 mA for T<T1 and 20 mA for T>T2 for a dead band of 10°C before going into error status at 22 mA.**

Fig. 2 reports the connection diagrams for the transmitters in the current loop. In order to obtain the maximum precision, the connection to the Pt100 should be performed with 3 wires and with wires having the same diameter so to grant the same impedance in each connection. The symbol RL (load) represents any device in the current loop that is to say an indicator, a controller, a data logger or a recorder.

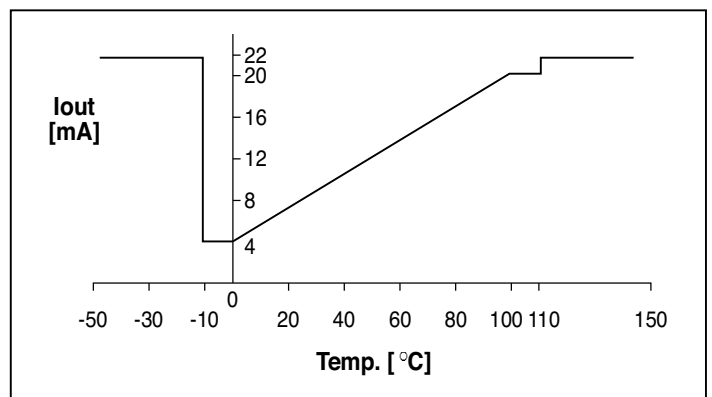

Fig. 1 Range 0...100°C, output current according to the temperature function.



### Programming

All transmitters are supplied by default with a range 0...100°C, anyway user can set a different range by using the following accessories:

- continuous 7-30 Vdc power source,
- Pt100 calibrator or set of precision resistors,
- precision ammeter with minimum range 0...25 mA,

And by following this procedure:

1. Connect the transmitter to set-up as shown in Fig. 2 and set the Pt100 calibrator at the required temperature suitable for 4 mA (for example, assuming that you want to set the range -50...+200°C, you will set the calibrator to -50°C or equivalently you will connect a resistance of 80,31Ω between terminals 1 and 3 while 1 and 2 shorted).
2. Wait 10 seconds until the measurement becomes settled, then keep pressed the programming key for at least 4 seconds, until the LED flashes once and remains lit. When the key is released the LED flashes.
3. Set the Pt100 calibrator at the required temperature for 20 mA (according to the above example, set the calibrator at +200°C, or alternatively connect 175.86Ω resistance between terminals 1 and 3 with 1 and 2 shorted).
4. Wait 10 seconds until the measurement becomes settled, then press the programming key for at least 4 seconds, until the LED stops flashing. Now release the key and the LED flashes twice. At this point the SET POINT procedure is completed.
5. Verify that the setting complies with the required specifications, setting the calibrator (or connecting the precision resistances) at the values corresponding to 4 and 20 mA and checking the current on the ammeter.

The temperature range programming can be performed by using some precision resistances of fixed value that simulate a Pt100 sensor value. For example, the resistance values corresponding to some temperature values are reported (see Tab. 1).

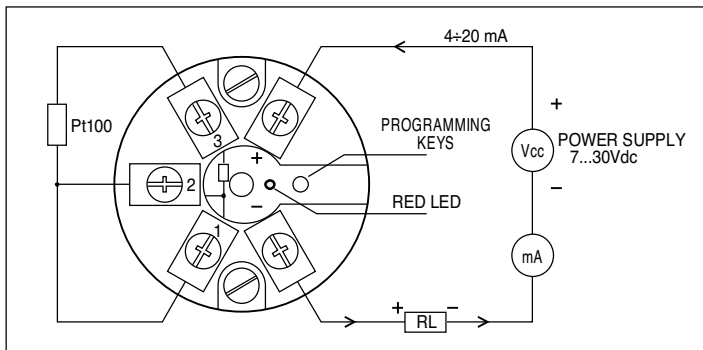

Fig. 2 Wiring diagram of the transmitters.

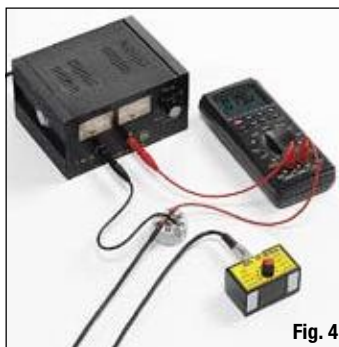

Fig. 4

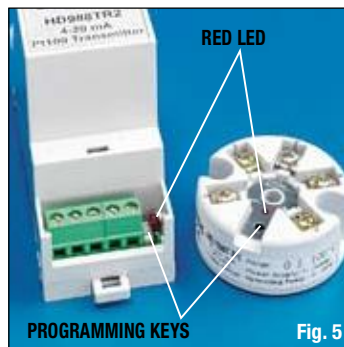

Fig. 5

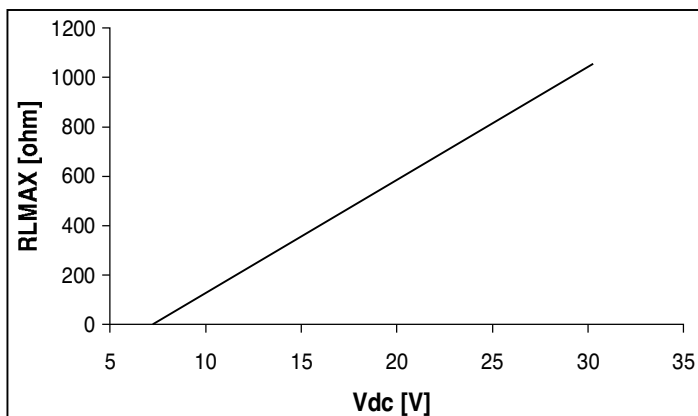

Fig. 3 Load with relation to the feeding voltage.

### PURCHASING CODES

**HD 788TR1:** 4÷20 mA/20÷4 mA temperature transmitter for 2 or 3 wires Pt100 sensor configurable in the range -200...+650°C with minimum amplitude range 25°C, in a container for DIN B 43760 heads.

**HD 788TR1-I:** 4÷20 mA/20÷4 mA temperature **isolated** transmitter for 2 or 3 wires Pt100 sensor configurable in the range -200...+650°C with minimum amplitude range 25°C, in a container for DIN B 43760 heads.

**HD 786TR1:** 4÷20 mA/20÷4 mA temperature transmitter for 3 wires Pt100 sensor configurable in the range -200...+650°C with minimum amplitude range 25°C. Suitable for mounting on wall.

**HD 988TR1:** 4÷20 mA/20÷4 mA temperature transmitter for 2 or 3 wires Pt100 sensor configurable in the range -200...+650°C with minimum amplitude range 25°C, in a container for 35 mm DIN bar connection, dimension 1 module.

**HD 988TR1-I:** 4÷20 mA/20÷4 mA temperature **isolated** transmitter for 2 or 3 wires Pt100 sensor configurable in the range -200...+650°C with minimum amplitude range 25°C, in a container for 35 mm DIN bar connection, dimension 1 module.

**HD 988TR2:** 4÷20 mA/20÷4 mA temperature transmitter for 2 or 3 wires Pt100 sensor configurable in the range -200...+650°C with minimum amplitude range 25°C, in a container for 35 mm DIN bar connection, dimension 2 modules, with 3½ digit LCD, height 10 mm.

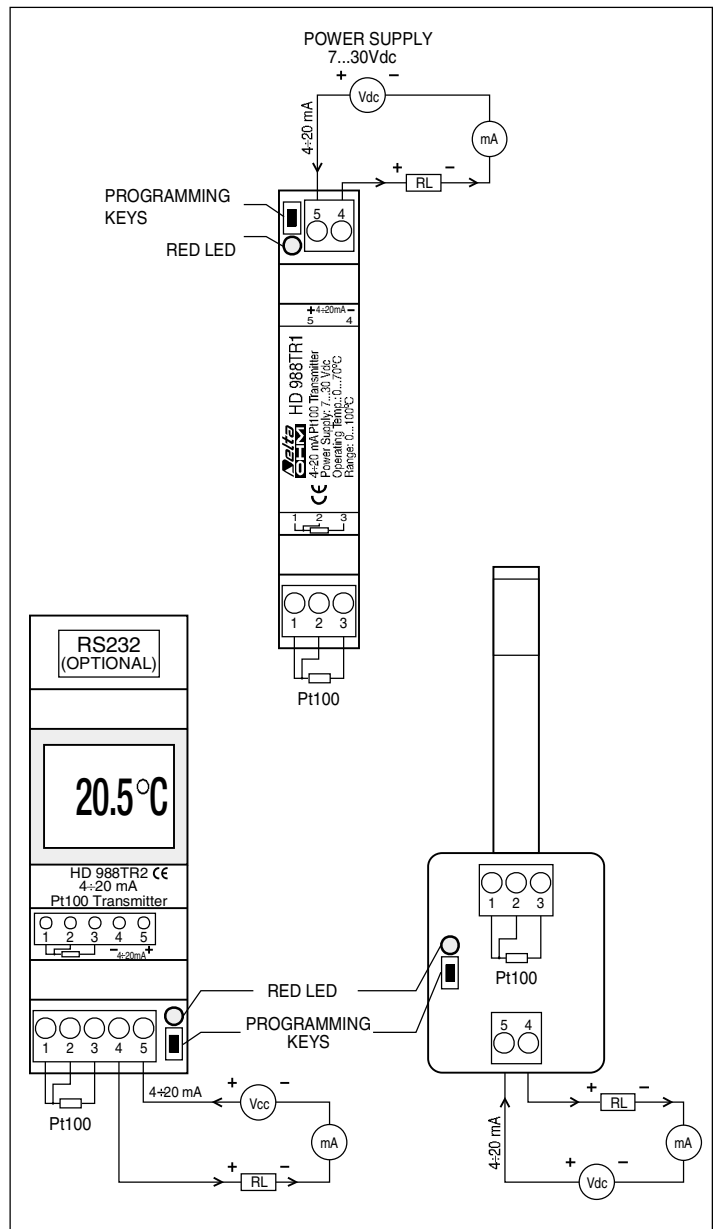

Fig. 6





POWER SUPPLY:	
Input voltage:	12÷24 V ± 10%, 65 mA
Linearity:	0,2%
Zero drift:	0,02%/°C referred to full scale
Full scale drift:	0,02%/°C referred to applied signal
Response time:	0,3 seconds at 63% of final value 1 second at 99,9% of final value
Insulation:	3kV at 50 Hz for 1 minute
Operating Temperature:	-10°C...+50°C (it is the maximum temperature electronics can operate in)

**Variation of jumper connections according to the output measuring range, relative retouch trimmers for start of scale and full scale.**

Measuring range	Output	Setup of jumper connections			TRIMMER*		
		J1	J2	J3	Start of scale	End of scale	
1	-50 ÷ 50°C	0÷10Vcc	A	A	A	RR1	RR2
2	0 ÷ 50°C	0÷10Vcc	B	A	A	RR1	RR2
3	0 ÷ 100°C	0÷10Vcc	C	A	A	RR1	RR2
4	0 ÷ 200°C	0÷10Vcc	D	A	A	RR1	RR2
5	0 ÷ 400°C	0÷10Vcc	E	A	A	RR1	RR2
1	-50 ÷ 50°C	0÷20mA	A	B	A	RR1	RR2
2	0 ÷ 50°C	0÷20mA	B	B	A	RR1	RR2
3	0 ÷ 100°C	0÷20mA	C	B	A	RR1	RR2
4	0 ÷ 200°C	0÷20mA	D	B	A	RR1	RR2
5	0 ÷ 400°C	0÷20mA	E	B	A	RR1	RR2
1	-50 ÷ 50°C	4÷20mA	A	B	B	RR1	RR2
2	0 ÷ 50°C	4÷20mA	B	B	B	RR1	RR2
3	0 ÷ 100°C	4÷20mA	C	B	B	RR1	RR2
4	0 ÷ 200°C	4÷20mA	D	B	B	RR1	RR2
5	0 ÷ 400°C	4÷20mA	E	B	B	RR1	RR2

\* Multi-turn trimmers RR1 RR2 are needed for slight calibration adjustments of start of scale and full scale. If not strictly necessary it is advisable not to operate them, calibration being already carried out in the laboratory. Setup of connection terminals, jumper connections of output and range configuration, retouch trimmers of scale beginning and full scale.

## HD 688T MODULAR TEMPERATURE TRANSMITTER

HD 688T modular temperature transmitter, Pt100 sensor, with galvanic separation between input/output and power supply

Output analogue signal: 0÷20 mA / 4÷20 mA / 0÷10 Vcc.

The HD 688T transmitter is made up of the following stages:

- input stage including linearization of the curves and equalization of the resistance of the line cable (3 wires) of Pt100, conversion from voltage into frequency;
- universal output stage through jumper connection, conversion from frequency into voltage;
- power supply stage.

The configuration of the measuring range or the output signal can be modified at any time; an outstanding feature is that any variation does not require calibrating the transmitter again.

### SPECIFICATIONS

INPUT:	CONFIGURATION:
Input signal:	Pt100 (IEC 751)
Measuring range:	-50...+50°C / 0...+50°C / 0...+100°C 0...+200°C / 0...+400°C
Measuring current:	1 mA
OUTPUT:	
Output signals:	0÷10Vdc, 0÷20 mA, 4÷20 mA
Maximum load:	5 mA 500Ω
Output impedance:	0,1Ω, 1MΩ, 1MΩ

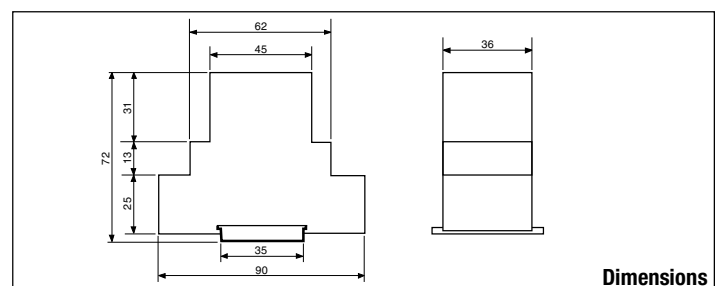
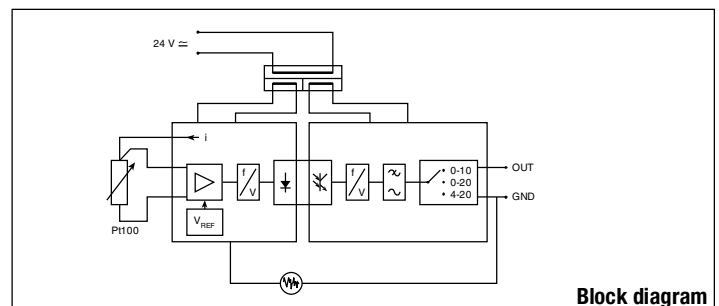
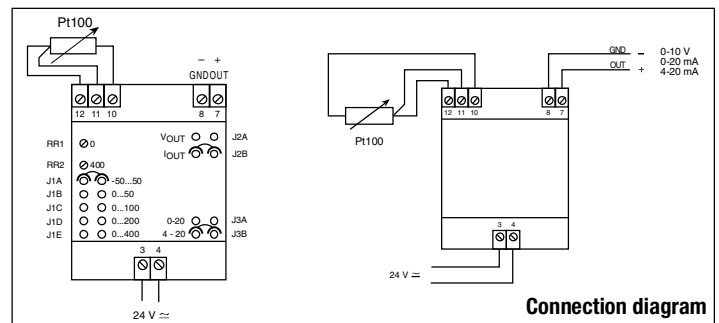

Temperature



## HD 2047 Pt100 SIMULATOR

HD 2047 is a portable instrument specially designed for testing and calibrating instruments with Pt100 (100Ω a 0°C) type input and voltage/current outputs such as, for instance, active and passive temperature transmitters, recorders, testers and data loggers, etc

HD 2047 simulates up to 24 fixed values of a Pt100 sensor in the range from -100°C up to +500°C, with a 2, 3 or 4 -wire connections. The selection of the value to simulate is via a rotary switch placed on the front of the instrument. Whatever operating mode you choose, the Pt100 output is always active

HD 2047 can measure with high accuracy voltage/current outputs of any transmitter connected to the instrument input: -20V...+20V continuous voltage range and 0...22mA continuous current range. Eventually it can also calibrate and test the functioning of a passive transmitter by simulating the temperature input, providing power supply to the transmitter and at the same time reading the current flowing in: all this is performed without external power supply auxiliary.

The instrument is equipped with three keys:

**ON/OFF** switches the instrument on and off. Once switched on, HD 2047 is ready for the voltage measurement.

**MODE** selects in cycling the type of operation; by pressing the button in succession, you enable in order:

1. voltage measurement;
2. current measurement;
3. current measurement by 4...20mA loop power supply.

**RANGE** in voltage or current measurement it allows to select the more suitable full range and resolution for the measurement under process: -1.999...+1.999, -19.99...+19.99 e -199.9...+199.9.

HD 2047 is internally protected against any kind of connecting error made by the operator: it is highly recommended anyway not to exceed voltage/current limits shown in technical specifications.

The battery signal appears on the display in order to indicate that batteries are low and need to be replaced.

## Operating modes

### 1) How to measure DC voltage input

The instrument measures positive and negative continuous voltages up to 20V maximum amplitude..

Procedure (see fig.1):

- select "input voltage" operating mode by pressing MODE key. The red led corresponding to "READ V" lights up;
- connect the wires to the sockets, as reported in fig.1;
- select the correct range depending on the voltage, by pressing RANGE key. An OverRange measurement is indicated by a 1 sign, lighted on the display left part: in this case you just press RANGE key to pass to the following measuring range.

Note: a) **For safety reasons, never apply any voltage superior to 48Vdc to the sockets.**

b) **The instrument only measures continuous voltage.**

### 2) Hot to measure DC current input

The instrument measures positive and negative current up to 22mA maximum amplitude.

Procedure (see fig.2):

- select "input current" operating mode by pressing MODE key. The red led corresponding to "READ mA" lights up;"
- connect the wires to the sockets, as reported in fig.2 observing the correct polarity: in order to be read, current must be from the bush +
- select the correct range depending on the current, by pressing RANGE key. An OverRange measurement is indicated by a 1 sign, lighted on the display left part: in this case you just press RANGE key to pass to the following measuring range.

Note: a) **The instrument measures continuous current up to a 22mA maximum amplitude.**

b) **The instrument only measures continuous current.**

c) **The instrument is provided with an internal protection circuit to limit the current within 25mA.**

### 3) How to calibrate and test passive transmitters

The instrument can power a 4...20mA loop, measure the current and simulate 24 fixed values of a Pt100 at the input of a temperature transmitter, with no external power supply required.

Procedure (see fig.3):

- select "2 WIRE" operating mode by pressing MODE key. The corresponding red led lights up
- connect the 4...20mA loop wires to the left sockets, as shown in fig. 3, without changing the correct polarity; the current supplied by HD 2047 is delivered through the positive (+) socket
- select the correct range depending on the current, by pressing RANGE key. An OverRange measurement is indicated by a 1 sign, lighted on the display left part: in this case you just press RANGE key to pass to the following measuring range
- select the temperature value by turning the rotary switch.

Note: a) **The maximum amplitude of the output current equals 25mA.**

b) **A 14Vdc voltage is supplied to the current loop.**

c) **In case of 2 or 3-wire connections, do not make jumpers on unused sockets; it is highly recommended to leave them free.**

### 4) How to simulate a Pt100 sensor

The instrument can simulate 24 temperature fixed values of a Pt100 sensor (100Ω at 0°C, coefficient  $\alpha=0.003850$ ) with 2, 3 or 4-wire connections. The selection is made through a rotary switch placed on the front part of the instrument.

Procedure:

- perform the connection as reported in figures 3, 4 or 5 according to the number of wires;
- select the temperature value by turning the rotary switch.

Note: a) **In case of 2 or 3- is highly recommended to leave them free.**

b) **MODE and RANGE keys have no effects on the resistance selection..**

c) **The internal protection circuit reduces to approximately 1.2V the drop on resistances: this means the measuring current has a maximum amplitude of 20mA.**



## TECHNICAL DATA (@ 20°C)

GENERAL	
Power supply	4 batteries 1.5V, AA size (the input for the 9Vdc external supplier is provided only upon request)
Autonomy with 1.5V Batteries and 2250mAh capacity	160 h (in "V READ" and "mA READ" operating mode) 30 h @ loop current = 12mA (in "2 WIRE" operating mode)
Low batteries signal	The battery sign lights up with a battery voltage of about 3.6V
Operating temperature	-5...+50°C
Operating relative humidity	0...90%RH (no condensation)
Weight/dimensions	580 g (without Batteries) / 23x70x230 mm
CONTINUOUS VOLTAGE MEASURE	
Measuring range	-1.999V...+1.999V: resolution 1mV -19.99V...+19.99V: resolution 10mV
Accuracy	±1mV: nel range -1.999V...+1.999V ±10mV: nel range -19.99V...+19.99V
Input resistance	1MΩ
Maximum voltage applied to terminals	48Vdc
CONTINUOUS CURRENT MEASURE	
Measuring range	0.00mA...19.99mA: resolution 10μA 0.0...22.0mA: resolution 100μA
Accuracy	±(0.01mA+0.05% of the range): in the range 0.00mA...19.99mA ±0.1mA: in the range 0.0mA...22.0mA
Shunt resistance	20Ω
Overload protection	Current limit: 25mA
PASSIVE TRANSMITTERS: POWER SUPPLY/ MEASURE	
Measuring range	0.00mA...19.99mA: resolution 10μA 0.0...22.0mA: resolution 100μA
Accuracy	±(0.01mA+0.05% of the range): in the range 0.00mA...19.99mA ±0.1mA: in the range 0.0mA...22.0mA
Shunt resistance	20Ω
Overload protection	Current limit: 25mA
Maximum load @20mA	700Ω
Applied voltage	14Vdc
SIMULATING A Pt100	
Type of RTD	Pt100 (100Ω a 0°C, α=0.003850, EN60751, IEC751, BS1904)
Temperature values	24 fixed values from -100 to +500°C
Precision	±0.05% of the simulated value
Room temperature effect	±5ppm / °C
Maximum power loss	125mW
Maximum load current	20mA

## PURCHASING CODES

**HD 2047:** Pt100 Simulator measures current loop and voltage signals coming from transmitters. The kit consists of instrument equipped with Batteries, 2 connection cables L=600 mm, one is a 4 wires, the other is a 2 wires.

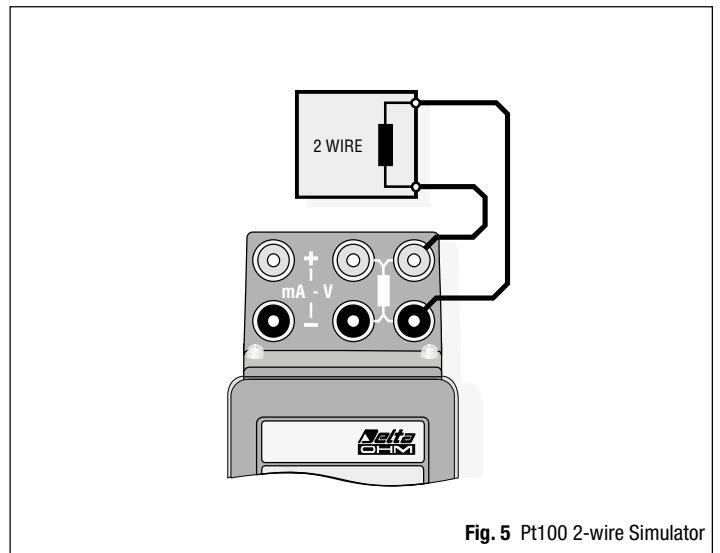

Fig. 5 Pt100 2-wire Simulator

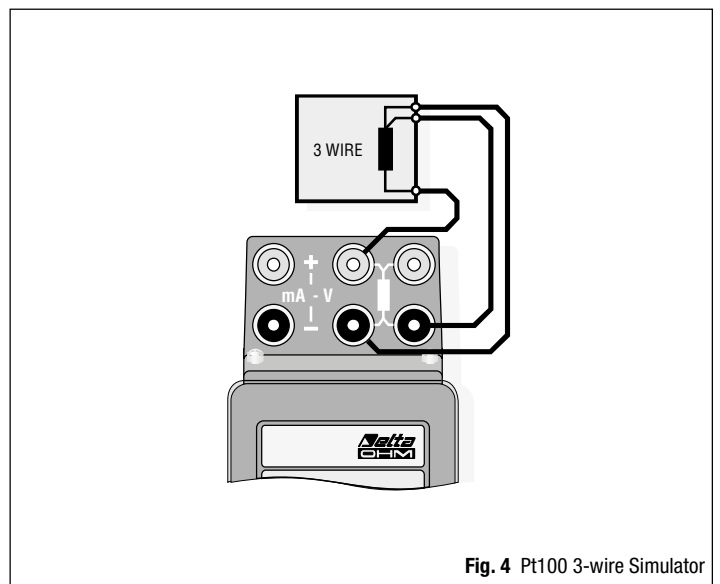

Fig. 4 Pt100 3-wire Simulator

Temperature

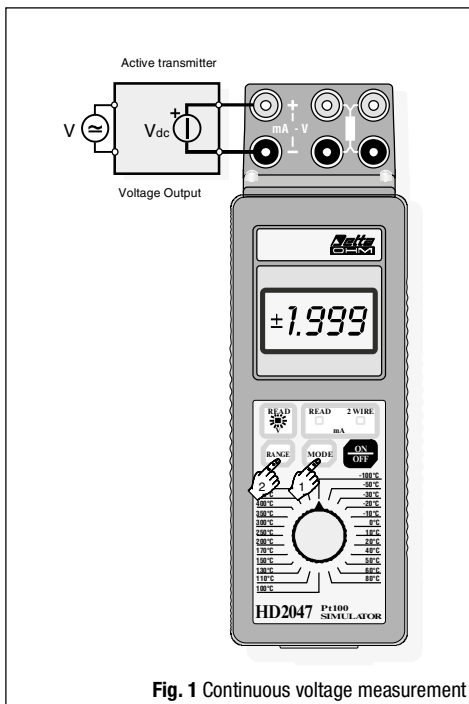

Fig. 1 Continuous voltage measurement

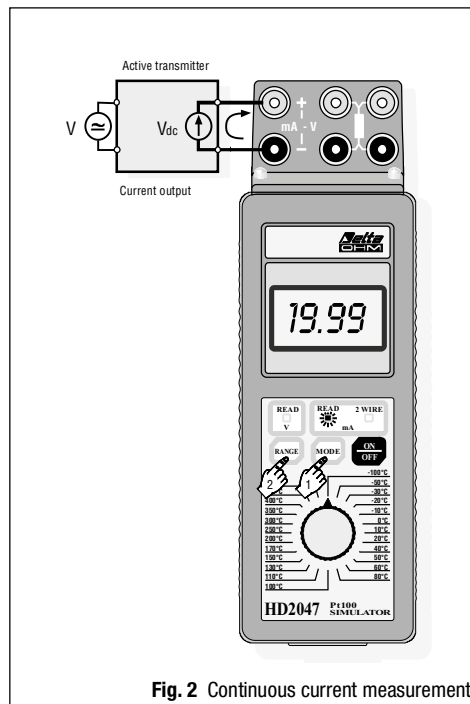

Fig. 2 Continuous current measurement

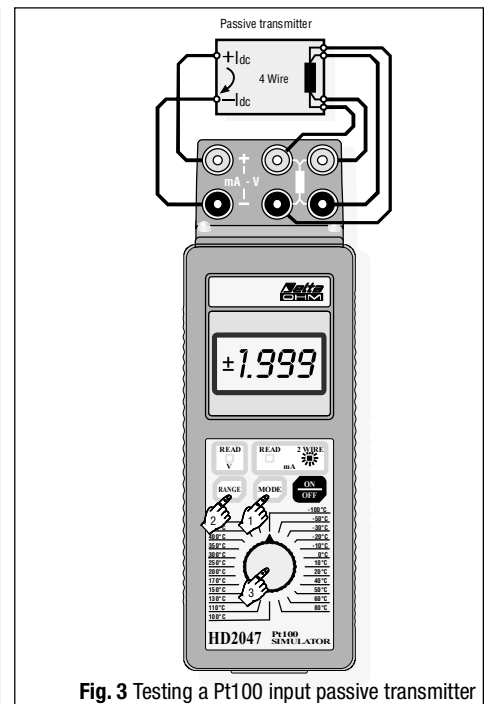

Fig. 3 Testing a Pt100 input passive transmitter





**4÷20mA CONFIGURABLE TEMPERATURE TRANSMITTERS FOR K-J-T-N TYPE THERMOCOUPLE THERMOCOUPLE GENERATOR MANAGED BY PC THROUGH RS232C HD778-TCAL**

HD 778TR1, HD 978TR1 and HD 978TR2 are 4...20mA two-wired configurable passive transmitters with microprocessor for **K, J, T** and **N** type thermocouple sensors. They convert the voltage value generated by the thermocouple into a linear current signal included in the range 4...20mA. The use of digital devices allows obtaining an excellent precision and stability in time. User can set the 4...20mA (or 20...4mA) output into any temperature range in the measuring range included in the measuring range of the single thermocouple with a **minimum range of 50°C**. The range and type of thermocouple are set by simply using one button. A led indicates the alarm situation (broken or not connected sensor) and it helps user during the programming. Moreover, transmitters are protected against polarity inversions. HD778TR1 is specifically designed to be installed in DIN B type connection heads, HD978TR1 and HD978TR2 are suitable for mounting on 35 mm DIN bars. Beyond 4...20mA output, HD978TR2 has a 3½ digit (Height 10 mm) display which allows displaying the measured temperature.

**TECHNICAL DATA @ 25°C e 24Vcc**

INPUT	HD778TR1	HD978TR1	HD978TR2
Sensor	Thermocouple type K, J, T and N		
Connection	2 wires passive transmitter		
Measuring range	Thermocouple K: -200°C ... +1200°C Thermocouple J: -200°C ... +800°C Thermocouple T: -200°C ... +300°C Thermocouple N: -200°C ... +1200°C		
Linearization	EN 60584-1-2 ASTM E 230 - ANSI (MC96-1)		
Default range	Tc = K - Range = 0...1000°C		
Minimum measuring range	50°C		
Conversion speed	2 measures per second		
Accuracy	±0,04%FS±0,04% of the reading or 0,5°C (the greater of the two values)		
Operating temperature of the cold junction	-30 ... +80°C	0 ... +70°C	
Operating temperature	-30 ... +80°C	0 ... +70°C	
Storage temperature	-40...+80°C		
<b>OUTPUT</b>			
Type of output (note 1)	4...20 mA (or 20...4 mA) two wires 22 mA if sensor is broken or not connected		
Resolution	4 µA	4 µA Display: 0,1°C T<200°C 1°C T>200°C	
Power voltage	9...30V dc (protection against polarity inversion)		
Sensitivity to Vdc power voltage variations	0,4 µA/V		
Load resistance	R <sub>L</sub> Max = (Vdc-9)/0.022 R <sub>L</sub> Max = 625Ω con Vdc = 24 Vdc		
Input/output galvanic insulation	50Vdc (verified at 250V)		
Red led	It turns on while programming, when the probe is broken or not connected		
Heating time	2 minutes		

Note 1) If the measured temperature T goes out of the T1...T2 (T1<T2) set range, the transmitters linearly regulate the current for T<T1 and T>T2 for an interval of 10°C. (See the current diagram.)

**Installation and connection**

Fig. 1 shows the mechanical dimensions of the HD778TR1 transmitter and highlights the holes of 5 mm diameter for fastening the DIN head and the central hole for the entrance of the wires in the thermocouple. Fig. 1 reports the mechanical dimensions of the HD978TR1 and of the HD978TR2. The width of the HD978TR1 is a DIN (17,5 mm) module, the HD978TR2 is a 2 DIN (35mm) modules. The working temperature should be included in operating temperature declared. Fig. 4 and 5 report the wiring diagrams of the HD778TR1, HD978TR1 and HD978TR2. In order to obtain the maximum precision, the connection to the thermocouple should not exceed 3 meters long. In the diagrams reported, the RL (Load) symbol represents any device introduced in the current loop, that is to say any indicator, controller, data logger or recorder.

**CHOICE OF TYPE OF THERMOCOUPLE**

The transmitter accepts four types of thermocouple. The thermocouple set is highlighted by the number of flashes of the led when power is supplied.

N° of led flashes	Type of thermocouple
1	K
2	J
3	T
4	N

Transmitters come with the default set K thermocouple and range 4...20mA = 0...1000°C.

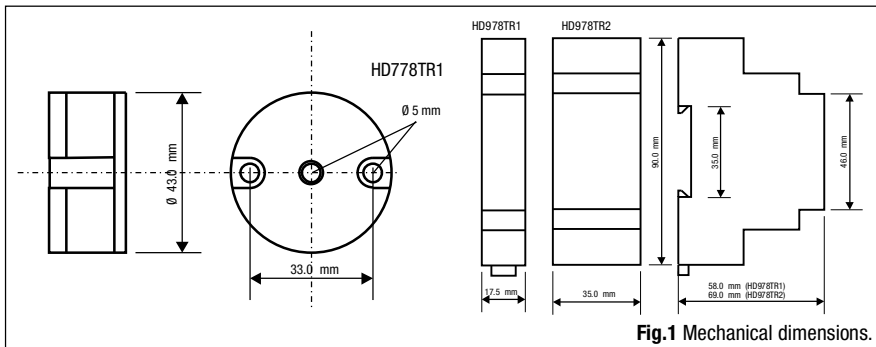

Fig.1 Mechanical dimensions.

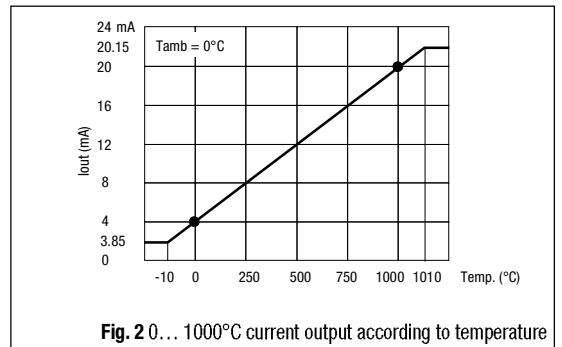

Fig. 2 0... 1000°C current output according to temperature



User can change the thermocouple type and the operating range according to the following procedure.

**Note: after changing the thermocouple type the operating range should be programmed.**

#### HD778TR1 and HD978TR1

Giving power to the transmitter, the led flashes for a number of times equal to the type of thermocouple previously configured.

In order to change the setting, remove and reapply supply to the transmitter by **pressing the button**.

This way you enter the programming for choosing the type of thermocouple: if you chose the **thermocouple K**, the led flashes once.

If you release the button and press it again within 10 seconds, the led flashes twice: **thermocouple J** has been chosen.

If you press the button in 10 seconds, the led flashes 3 times: **thermocouple T** has been chosen.

If you press the button in 10 seconds, the led flashes 4 times: **thermocouple N** has been chosen.

If you press the button in 10 seconds again, the led flashes once indicating that you chose thermocouple K again and the cycle re-starts.

In order to save the selected type of thermocouple, wait for 15 seconds without touching any key: the transmitter saves the type of thermocouple and exits programming, the led flashes for the number of times equal to the type of thermocouple selected.

**If you changed the type of thermocouple, you have to re-programme the operating range: see paragraph "Programming the operating range".**

#### HD978TR2

This transmitter has a double dip-switch for selecting the type of thermocouple. The selection must be set before ignition and is acquired when the instrument is on: **a change in the dip-switch when the instrument is powered has no effect until the next power cycle.**

Procedure:

when the instrument is off, select the type of thermocouple by setting the switches as shown in the figure below.

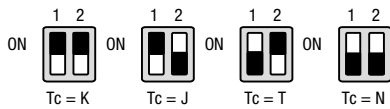

By powering the transmitter, the led flashes for a number of times equal to the type of thermocouple selected.

**If you changed the type of thermocouple, you have to re-programme the operating range: see paragraph "Programming the operating range".**

#### Programming of the operating range

Transmitters HD778TR1, HD978TR1 and HD978TR2 are supplied by default with **K type thermocouple and range 0...1000°C**. The user can set a different range according to his requirements with a minimum span of 50°C. The correspondence between the read temperature and the output current can be direct (e.g. 4mA = 0°C and 20mA = 1000°C) or inverse (e.g. 4mA = 1000°C and 20mA = 0°C).

Acquire the following tools for programming:

- 9...30 Vdc direct current power source,
- thermocouple calibrator,
- Copper connection cables
- Precision ammeter with 0...25 mA minimum range.

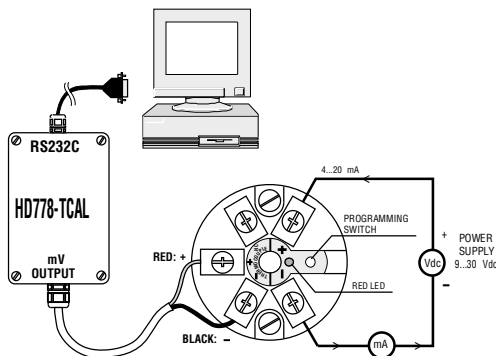

In place of the thermocouple calibrator, you can use the Delta Ohm **HD778-TCAL**: this instrument has to be connected to a serial port of the PC and, by means of a proper software, automates all the steps described below for programming the operating range.

If you have a thermocouple calibrator, the steps are:

in order to set the type of thermocouple, proceed as described in the paragraph "CHOICE OF THE TYPE OF THERMOCOUPLE".

**The voltage values generated by the calibrator must be uncompensated.**

**The setting must be done with the instrument already powered.**

Set the calibrator with the output of the desired type of thermocouple (K, J, T o N), connect the calibrator to the transmitter thermocouple input according to the polarity. **(Pay attention to polarity).**

Set the calibrator so that it generates the voltage corresponding to the temperature at 4mA, wait for 30 seconds for the voltage to stabilise.

**Press and hold the button** until the led flashes. Release the button. The instrument has acquired the first value of the transmitter working range, the led keeps on flashing. The instrument is now awaiting the second data of the full scale range.

Set the calibrator in order to generate a voltage corresponding to the temperature at 20mA.

**Press and hold the button** until the led stops flashing.

Release the button and wait **20 seconds, without changing the calibrator's data**, so that the transmitter saves the calibration data and is ready for working normally. The operation ends with a flashing of the led.

The instrument has acquired the second point corresponding to the range you want to set and is working normally.

**The minimum value accepted by the instrument span is 50°C.** If the user tries to insert a second value T2 with  $(T2-T1) < 50$ , after entering the first value T1 of the range, the instrument does not accept it and remains in standby while the led continuous flashing.

**The HD778-TCAL is supplied with its software. Linked to the HD778-TCAL serial output of a PC, the user can configure the transmitter by following the instructions on the screen.**

#### PURCHASING CODES

**HD778TR1:** 4...20mA/20...4mA 2 wire temperature transmitter for K, J, T and N thermocouples, configurable with minimum amplitude range 50°C, in a container for DIN B 43760 heads.

**HD978TR1:** 4...20mA/20...4mA 2 wire temperature transmitter for K, J, T and N thermocouples, configurable with minimum amplitude range 50°C, in a container for 35 mm DIN bar connection, dimension 1 module.

**HD978TR2:** 4...20mA/20...4mA 2 wire temperature transmitter for K, J, T and N thermocouples, configurable with minimum amplitude range 50°C, in a container for 35 mm DIN bar connection dimension 2 modules, with 3½ digit display, height 10 mm..

**HD778-TCAL:** power generator in the range -60mV...+60mV, regulated by PC through RS232C serial port, DELTALOG7 software for setting K, J, T and N thermocouple transmitters.

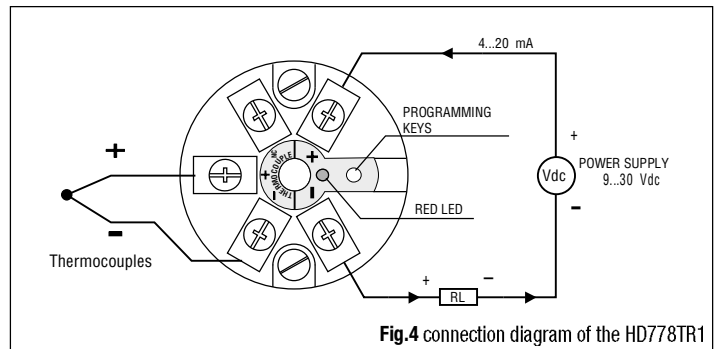

Fig.4 connection diagram of the HD778TR1

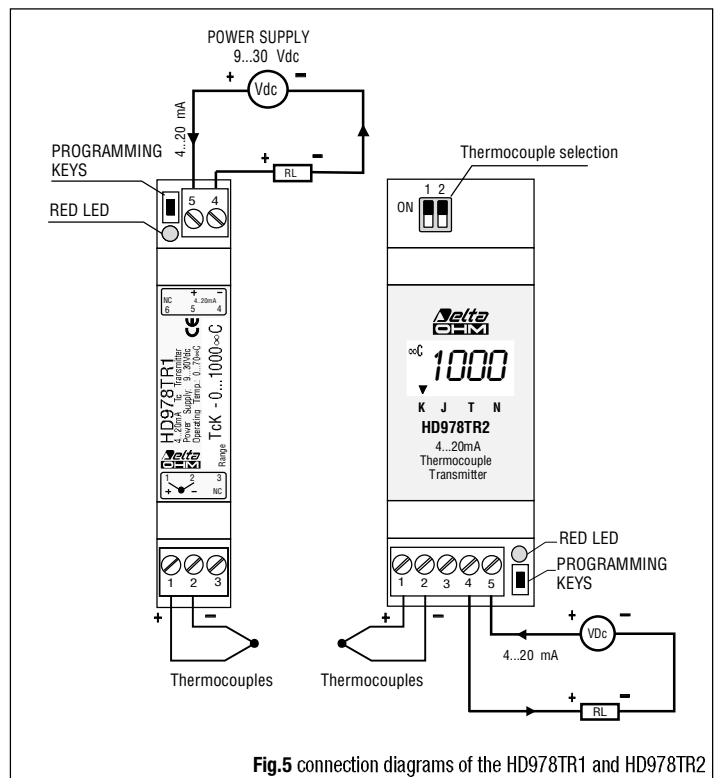

Fig.5 connection diagrams of the HD978TR1 and HD978TR2

Temperature



**HD 978TR3, HD 978TR4, HD 978TR5, HD 978TR6  
SIGNAL CONVERTERS / AMPLIFIERS WITH 4÷20mA OR 0÷10Vdc OUTPUT  
CONFIGURABLE WITH HD788-TCAL BY PC THROUGH RS232C**

**Configurable signal converters/amplifiers with current or voltage output.**

HD978TR3 and HD978TR4 are signal converters/amplifiers that can be configured using mV input. The mV input signal range can be configured from -10mV to +60mV through a button, by using the **HD778-TCAL simulator and DeltaLog7 software** or a gauge with mV output. HD978TR3 has a 4...20mA current output. HD978TR4 has a 0...10Vdc voltage output, with 0...1Vdc, 0...5Vdc and 1...5Vdc outputs available upon request.

A led indicates the alarm situation and it helps user during the programming. The instrument is also protected against polarity inversions.

**Input and output are galvanically isolated between them:** this is necessary to eliminate problems due to the mutual influence of the devices originated by disturbs caused by the different earth/ground paths.

The instrument is housed in a 2 modules Din (Width 35mm) container with standard connection for 35mm omega bar for the models HD978TR3 and HD978TR4; a wall container for the models HD978TR5 and HD978TR6.

The 4...20mA current output stage of HD978TR3 and HD978TR5 is a passive two-wire and it supplies power to the converter through the current loop.

**TECHNICAL DATA @ 25°C e 24Vdc**

INPUT	HD978TR3 - HD978TR5	HD978TR4 - HD978TR6
Measuring range	-10mV ... +60mV configurable	
Default range	0...20mV	
Minimum measuring range	2mV	
Input impedance	> 1 MOhm	
Conversion speed	2 measures per second	
Accuracy	±0.04%F.S. ±20mV	
Operating temperature	-30 ... +70°C	
Storage temperature	-40...+80°C	
Relative humidity	0...90%RH (without condensation)	
OUTPUT	HD978TR3 - HD978TR5	HD978TR4 - HD978TR6
Type of output (note 1)	4...20 mA (or 20...4 mA) two-wired 22 mA, in case of unconnected input	0 ... 10Vdc (0...1Vdc, 0...5Vdc, 1...5Vdc upon request)
Resolution	4 mA	20mV
Power supply	9...30Vdc for the 4...20mA current output	15...30Vdc (4mA) for the 0 ... 10Vdc current output, 10...30Vdc (4mA) for the other outputs
Protection against polarity inversion	40Vmax	
Sensitivity to Vdc power voltage variations	0,4 µA/V	2µA/V
Load resistance	$R_{LMax} = (Vdc-9)/0.022$ $R_{LMax} = 625\Omega$ with Vdc = 24 Vdc	> 10kΩ
Input/output galvanic isolation	50Vdc (verified at 250V)	
Red led	It turns on while programming, when the probe is broken or not connected	
Heating time	2 minutes	
Thermal drift	0.02% F.S./°C	

Nota 1: If the measured voltage V goes out of the V1...V2 (V1<V2) set range, the transmitters linearly regulate the output for V<V1 and V>V2 for an interval of 0.1mV. (See the diagrams of the outputs.)

**Installation and connection**

Fig.1 shows the mechanical dimensions of the HD978TR3 and TR4: the width of the container is a 2 modules DIN (35mm). Fig.5 reports the wiring diagrams of the HD978TR3 and a DeltaOhm pyranometer. Fig.6 indicates the typical connection of the HD978TR4.

In order to obtain the maximum precision, the connection to the thermocouple should not exceed 3 meters long and should be performed with a shielded cable. It is also recommended not to pass wiring near cable for power signals (electric motors, induction furnaces, inverter etc.). The working temperature should be included in declared operating temperature.

In the diagrams reported, the RL (Load) symbol represents any device introduced in the current loop, that is to say any indicator, controller, data logger or recorder. The two terminals reporting EARTH are connected internally between them and they are necessary to connect the ground terminal coming, for instance, by a pyranometer to the grounded, as you can see from the diagrams.

The response curves of the instruments are reported in figures 2 (current output of HD978TR3) and 3 (voltage output of HD978TR4).

Fig.7 reports, as an example, the connection to be performed for reading the voltage measured on a shunt DC: the converter assures the galvanic isolation between device and voltage or current output; also configurability allows to obtain the best correlation between read and amplified output voltage. We recommend that you pick up the signal by using a sheltered cable and by connecting the screen (shield) to terminal 9.

**Programming of the operating range**

**Converters HD978TR3, HD978TR4, HD978TR5 are HD978TR6 are supplied by default with**

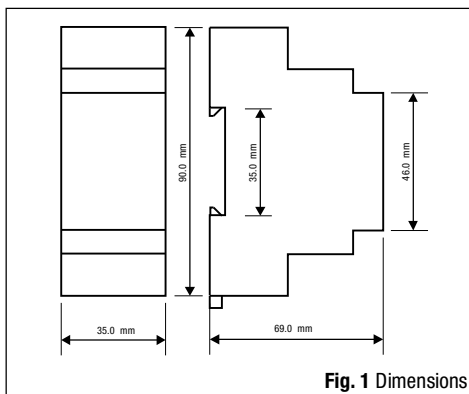

**Fig. 1 Dimensions**

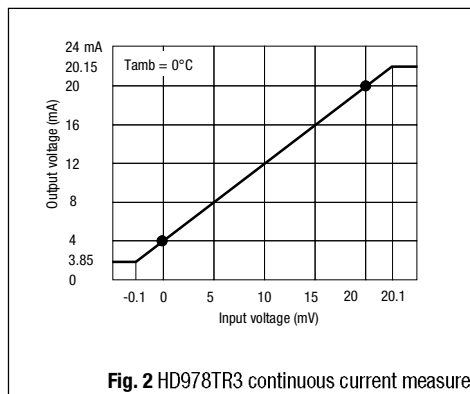

**Fig. 2 HD978TR3 continuous current measure**

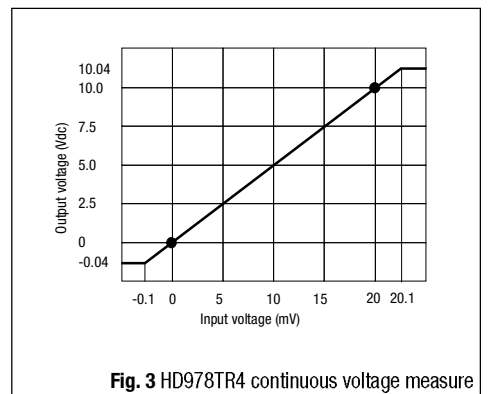

**Fig. 3 HD978TR4 continuous voltage measure**

range 0...20mV. The user can set a different range according to his requirements with a **minimum span of 2mV**. The correspondence between the read voltage and current or voltage output can be directed (for ex. 0mV / 4mA and 20mV / 20mA) or reverse (for ex. 20mV / 20mA and 0mV / 4mA).

Acquire the following tools for programming:

- source constant supply of suitable value (please see the specifications table),
- calibrator con mV output,
- connection cables,
- precision ammeter with 0...25 mA minimum range or 0...10Vdc voltmeter.

**The setting must be done with the instrument already powered.**

Set the calibrator so that it generates the voltage corresponding to the output of the initial scale of the converter (4mA or 0V according to the model), **by paying attention to polarity**. Wait 30 seconds for the voltage to stabilize.

**Press and hold the button** until the led starts flashing. Release the button. The instrument has acquired the first value of the transmitter working range, the led keeps on flashing. The instrument is now awaiting the second data of the full scale range.

Set the calibrator in order to generate a voltage corresponding to the output of the full scale (20mA or 10Vcc).

**Press and hold the button** until the led stops flashing.

Release the button and wait 20 seconds, **without changing the calibrator's data**, so that the converter saves the calibration data and is ready for working normally. The operation ends with a flashing of the led.

The instrument has acquired the second point corresponding to the range you want to set and is working normally.

**The minimum value accepted by the instrument is 2mV.** If the user tries to insert a second value V2 with V2-V1 lower than 2mV, after entering the first value first value V1 of the range, the instrument does not accept it and remains in standby while the led continuous flashing.

**Note:** in place of the current/voltage calibrator, you can use the Delta Ohm **HD778-TCAL**. This instrument has to be connected to a serial port of the PC and, by means of the proper **DELTA LOG7** software, automates all the steps described above for programming the operating range.

**The HD778-TCAL is supplied with its software. Linked to the HD778-TCAL serial output of a PC, the user can configure the HD978TR3 and HD978TR5 (4...20mA or 20...4mA**

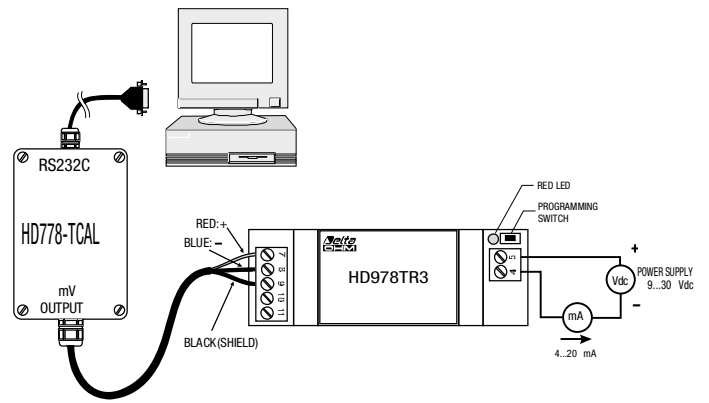

**current) or the HD978TR4 and HD978TR6 (0...10Vdc or 10...0Vdc voltage) by following the instructions on the screen.**

#### PURCHASING CODES

**HD978TR3:** Configurable signal converter amplifier with 4÷20mA (20÷4mA) output, for DIN bar

Input measuring range -10...+60mV. Default setting 0÷20mV.

Minimum measuring range 2mV.

**HD978TR4:** Configurable signal converter amplifier with 0÷10 (10÷0Vdc) output, for DIN bar

Input measuring range -10...+60mV. Default setting 0÷20mV.

Minimum measuring range 2mV.

**HD978TR5:** Wall mounting configurable signal converter amplifier with 4÷20mA (20÷4mA) output.

Input measuring range -10...+60mV. Default setting 0÷20mV.

Minimum measuring range 2mV.

**HD978TR6:** Wall mounting configurable signal converter amplifier with 0÷10 (10÷0Vdc) output.

Input measuring range -10...+60mV. Default setting 0÷20mV.

Minimum measuring range 2mV.

**HD778-TCAL:** power generator in the range -60mV...+60mV, regulated by PC through RS232C serial port, DELTA LOG7 software for setting K, J, T and N thermocouple transmitters.

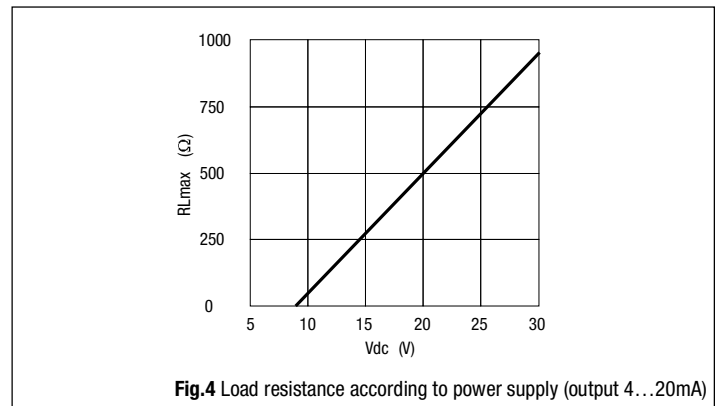

**Fig. 4** Load resistance according to power supply (output 4...20mA)

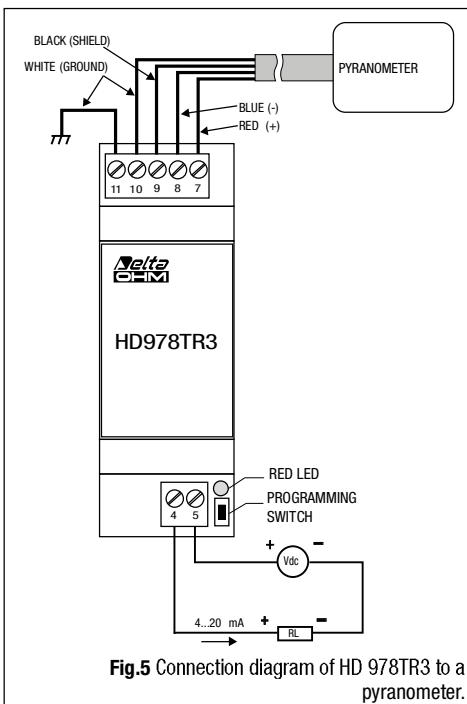

**Fig. 5** Connection diagram of HD 978TR3 to a pyranometer.

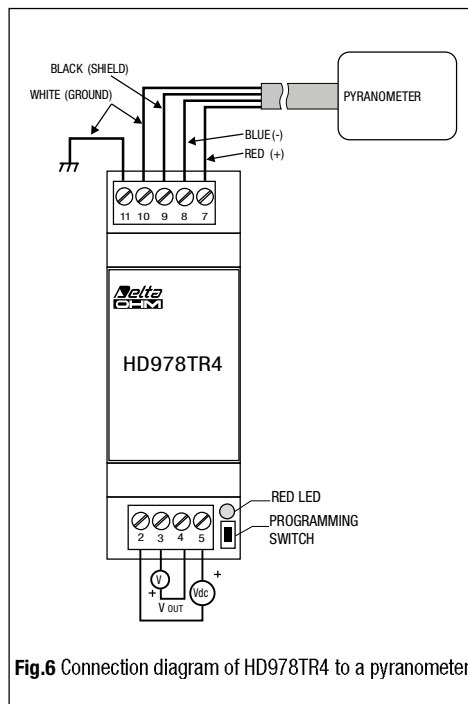

**Fig. 6** Connection diagram of HD978TR4 to a pyranometer

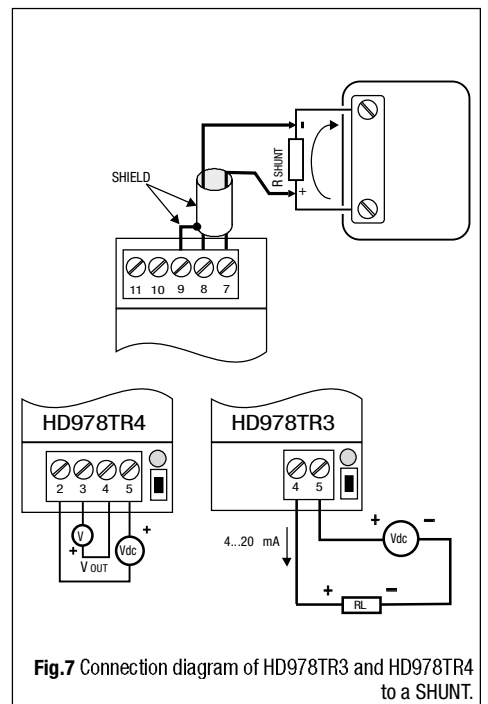

**Fig. 7** Connection diagram of HD978TR3 and HD978TR4 to a SHUNT.

Temperature

- Functions:
  - One relay with independent exchange contact for output HI (SP1, SP2).
  - One relay with independent exchange contact for output LO (SP3, SP4).
  - One relay with maximum or minimum alarm closing contact (L max, L min.) ALARM.
  - Resistive relay contacts 3A/220V 50Hz.
- Instrument working temperature: (electronic components) 5÷50°C.
- Power supply: there is a terminal board for input **12÷24Vac/Vdc** or **110÷240Vac/Vdc** (the one or the other; not both kinds of power supply).
- Instrument absorption: 5VA.
- Minimum power of the supply transformer: 20VA.

### Function of buttons on the frontal panel ,the LEDs

- 1 Numeric display. While programming you see: F0, F1, F2, F3, F4, F5, F6, F7, F8, SP1, SP2, SP3, SP4, S10.
- 2 Status indicator relay HI.
- 3 Status indicator relay LO.
- 4 Status indicator relay ALARM.
- 5 Decimal point.



### SEQUENTIAL PROGRAMMING OF WORKING PARAMETERS

- 6 **PROG** Each time you press this button, the program advances one instruction (F0, F1, F2, F3, F4, F5, F6, F7, F8, SP1, SP2, SP3, SP4, S10).
- 7 **ENTER** Pressing the button during programming you receive the value of the selected variable that can be changed with the buttons ▲ ▼; when pressing **ENTER** you confirm the value stored.
- 8 ▲ Pressing the button during programming you increase the displayed value; in F2, you move the decimal point to the right. In normal operation it flashes to indicate the value in Volts, mA or Pt100 corresponding to the input; with a second impulse it returns to normal operation.
- 9 ▼ Pressing the button during programming you decrease the displayed value; in F2, you move the decimal point to the left. In normal operation it flashes to indicate the value in Volts, mA or temperature corresponding to the input; with a second impulse it returns to normal operation.



## HD 9022 CONFIGURABLE MICROPROCESSOR INDICATOR VOLTAGE, CURRENT OR Pt100 INPUT

The microprocessor-controlled panel instrument HD 9022 is an indicator with alarm thresholds that may be programmed and configured by the user. It accepts input signals from 2 or 3 wires transmitters both 0÷1V, 0÷10V voltage and 0÷20 mA, 4÷20 mA current or 4 wires Pt100. Configurability is always all present inside the instrument, no add-on cards are required.

The choice for the configuration of the input signals is via keypad on the front of the instrument.

The dimensions of the instrument are 96x48 mm, width 145 mm according to DIN 45700.

The operating mode of HD 9022 is chosen according to the application and configuring the instrument by the keyboard. In a very easy way it is possible to configure the instrument in a range so to adapt it to changing process requirements. The configuration regards input, field scale, set point and auxiliary outputs.

### Applications

Typical applications are the display of signals sent by transmitters which may concern temperature, humidity, pressure, speed, capacity, level, force, etc., for the most varied industrial sectors, operating machines and automated systems.

### Specifications

- Configurable set point from -9999 to +19999.
- red leds indication with seven 1/2 inch segments,
- Separate clamp for voltage input 0÷1 / 0÷10V, current input 0÷20 / 4÷20 mA and Pt100 input (-200÷+800°C).
- The instrument has an auxiliary power supply: -5 Vdc max 10 mA and +15 Vdc non stabilized max 40 mA for the possible supply of 2-wire transmitters.
- $R_{in} = 25 \Omega$ ,  $R_{vin} = 200 k\Omega$ .
- Instrument accuracy:  $\pm 0.1\% R_{dg} \pm 1$  Digit.
- A/D converter resolution: 0.05 mV/Digit, 1  $\mu$ A/Digit.

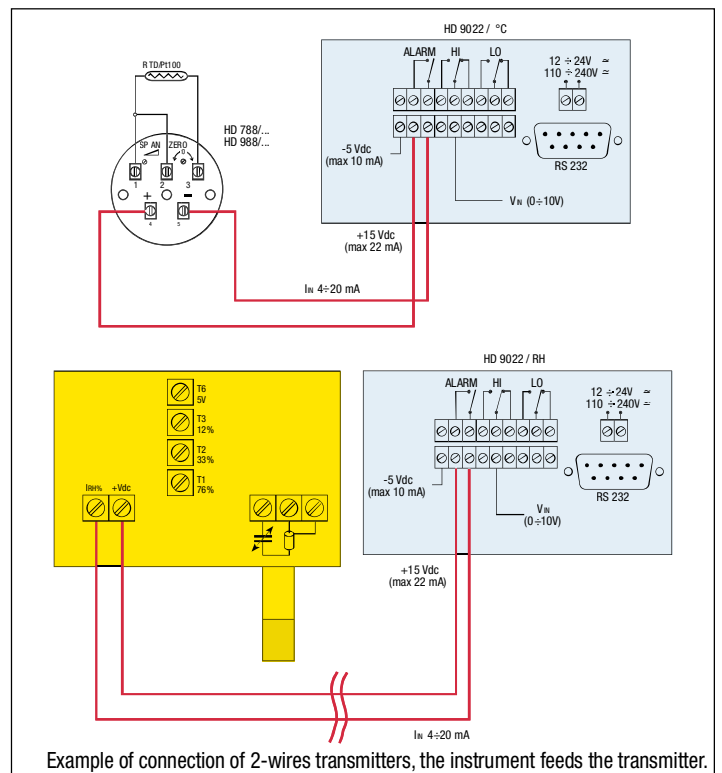



### Configuration of the HD 9022 panel indicator

- 1) Supply power to the instrument.
- 2) The instrument performs an internal check, the wording C.E.I. appears for a few seconds followed by a number at random.
- 3) Press **PROG** and the message **F0** appears
- 4) Press **PROG** and the message **F1** appears.
- 5) Press **ENTER** and the symbol U, A or Pt appears. Using the **▲▼** buttons, choose the input for voltage: U, current: A or Pt100: Pt signals. Press **ENTER** to confirm.
- 6) Press **PROG** and the message **F2** appears; press **ENTER**; with the **▲▼** keys, set the decimal point in the desired position.



Press **ENTER** to confirm.

- 7) Press **PROG** and the message **F3** appears; press **ENTER**, with the **▲▼** keys, set the voltage, current or Pt100 value (as desired) corresponding to the beginning of the scale S1 for example 0V, 4 mA or 0°C. Press **ENTER** to confirm.
- 8) Press **PROG** and the message **F4** appears; press **ENTER**, with the **▲▼** keys, set the numerical value corresponding to the beginning of the scale R1 for example 0°C. Press **ENTER** to confirm.
- 9) Press **PROG** and the message **F5** appears; press **ENTER**, with the **▲▼** keys, set the voltage or current value (as selected in point 5) corresponding to the end of the scale S2 for example 10V, 20 mA or 200.0°C. Press **ENTER** to confirm.
- 10) Press **PROG** and the message **F6** appears; press **ENTER**, with the **▲▼** keys, set the numerical value corresponding to the end of the scale R2 for example 100°C. Press **ENTER** to confirm.
- 11) Press **PROG** and the message **F7** appears; press **ENTER**, with the **▲▼** keys, set the maximum alarm threshold value L max for the Alarm relay for example 110°C. Press **ENTER** to confirm.
- 12) Press **PROG** and the message **F8** appears; press **ENTER**, with the **▲▼** keys, set the minimum alarm threshold value L min for the Alarm relay for example -10°C. Press **ENTER** to confirm.
- 13) Press **PROG** and the message **SP1** appears; press **ENTER**, with the **▲▼** keys, set the Set value for the first threshold "SET relay HI" for example 40°C. Press **ENTER** to confirm.
- 14) Press **PROG** and the message **SP2** appears; press **ENTER**, with the **▲▼** keys, set the Reset value for the first threshold "RESET relay HI" for example 45°C. Press **ENTER** to confirm.

- 15) Press **PROG** and the message **SP3** appears; press **ENTER**, with the **▲▼** keys, set the Set value for the second threshold "SET relay LO" for example 50°C. Press **ENTER** to confirm.
- 16) Press **PROG** and the message **SP4** appears; press **ENTER**, with the **▲▼** keys, set the reset value for the second relay "RESET relay LO" for example 48°C. Press **ENTER** to confirm.
- 17) Press **PROG** and the message **S10** appears. Press **ENTER**, with the **▲▼** keys, set the desired speed of RS232 serial transmission among the following ones: 300, 600, 1200, 2400, 4800, 9600 baud. Press **ENTER** to confirm.
- 18) Press **PROG** and the message **F0** appears. AT THIS POINT THE CONFIGURATION OF THE INSTRUMENT IS COMPLETE.
- 19) Connect the input of the instrument, press the **ENTER** key and the display will indicate the value corresponding to the input signal.

### Varying the configuration

To vary a stored parameter at any stage of the program it is sufficient to the step of the program to be changed with the **PROG** key (F1, F2, F3, etc.). Press **ENTER** and use the **▲▼** keys to modify the parameter previously set; press **ENTER** to confirm, return to **F0** and press **ENTER**.

This simple procedure modifies the desired step of the program.

### Note

If the **ENTER**, **▲** or **▼** key is pressed independently during operation, the instrument input value (V, mA or °C) flashes on the display. To return to normal operation, press the **▲▼** or **ENTER** key independently again.

### Error report

The instrument indicates an error signal in the following cases:

- OFL:** this appears when the set value of **R max** is exceeded.
- OFL:** this appears when the set value of **R min** is exceeded.
- E1:** this appears when the set points P1 and P2 require a resolution of the A/D converter higher than the one available.
- E2:** this appears when the values of F7 and F8 are inverted.

THE MAXIMUM RESOLUTION OF THE CONVERTER IS: 0.05 mV/Digit, 1µA/ Digit.

Summary of programming steps

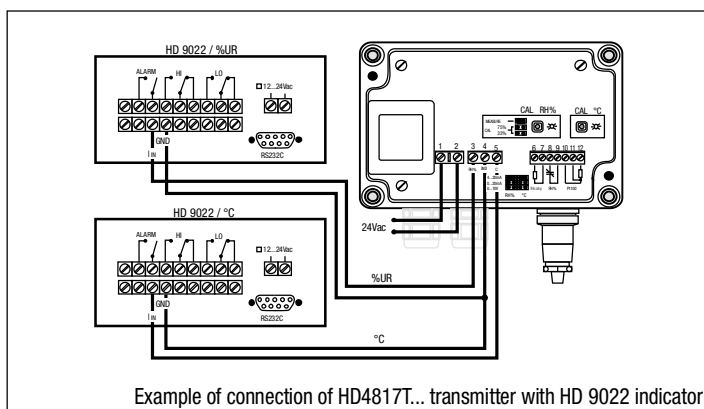
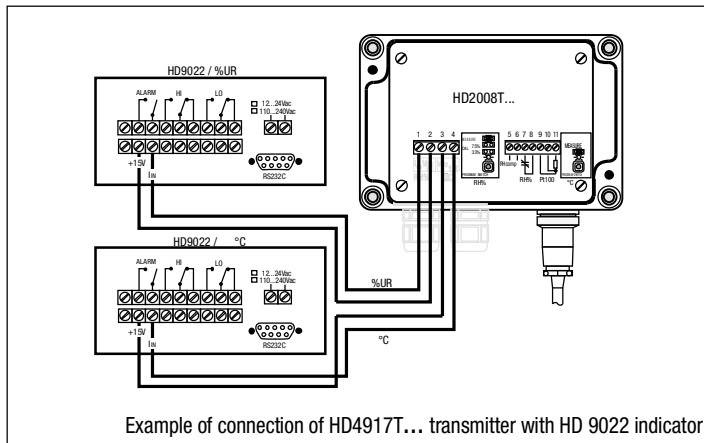
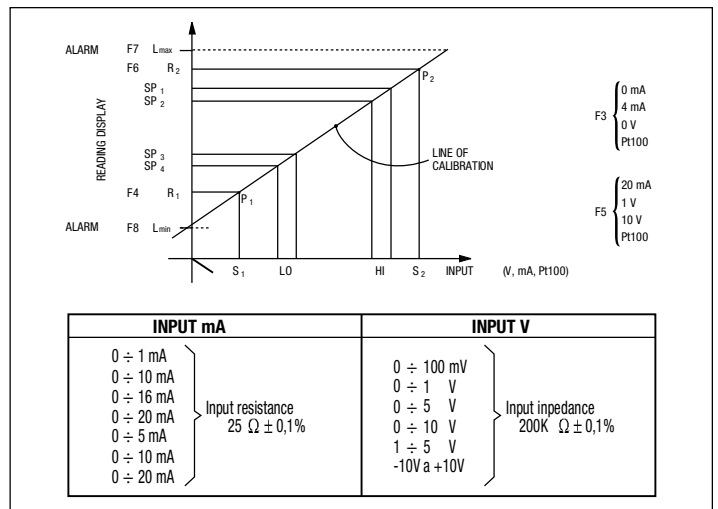

- PROG** Programming start. Selects the programming step, F0.
- PROG** Selects the programming step, F1.
- PROG** Selects the programming step, F2.
- PROG** .....
- ENTER** Exit program mode.
- ENTER** Allows modification of the variable.
- ▲▼** Modifies the variable on display.
- ENTER** Confirms the modification.
- PROG** Moves to next programming step.

Temperature

STEP	COMMENT	LIMITS
F0	Exit, by pressing <b>ENTER you exit the programming</b>	
F1	Select of the type of input: Voltage, Current, Pt100	$U - I - Pt$
F2	Decimal point position	0 - 0.0 - 0.00 - 0.000
F3	Value of zero scale input (Voltage, Current, °C)	0...10,00V, 0...20,00 mA -200,0...+800,0°C
F4	Value of initial scale of the display	-9999...19999
F5	Value of full scale input (Voltage, Current, °C)	0...10,00V, 0...20,00 mA -200,0...+800,0°C
F6	Value of full scale input	-9999...19999
F7	MAXIMUM ALARM threshold for intervention	-9999...19999
F8	MINIMUM ALARM threshold for intervention	-9999...19999
SP1	ON set-point threshold HI	-9999...19999
SP2	OFF set-point threshold HI	-9999...19999
SP3	ON set-point threshold LO	-9999...19999
SP4	OFF set-point threshold LO	-9999...19999
S10	Serial transmission speed	300, 600, 1200, 2400, 4800, 9600

### Serial interface RS-232C

The HD 9022 is equipped with standard serial interface RS-232C which is available on the SUB D male 9-pin connector. The arrangement of the signals on this connector is as follows:

Pin	Signal	Description
2	TD	Datum transmitted by the HD 9022
3	RD	Datum received by the HD 9022
5	GND	Reference logic mass

The transmission parameters with which the instrument is supplied are:

- baud rate 9600 baud
- parity None
- n. bits 8
- stop bit 1

The data transmission speed may be changed by altering the set-up parameter S10 with the keyboard; the possible baud rates are: 9600, 4800, 2400, 1200, 600, 300. The other transmission parameters are fixed.

All the messages reaching and leaving the HD 9022 must be inserted in a "Communication frame" with the following structure:

<Stx><Record><Etx>

Where:

- <Stx> Start of text (ASCII 02)
- <Record> constitutes the message
- <Etx> End of text (ASCII 03)

### Host commands

The structure of the command records is as follows:

<Command character> <Sub-command> <Values>

Where:

- <Command character> is characterized by an alphabetic character indicating the set of commands.
- <Sub-command> is characterized by a character indicating the type of command.
- <Values> is characterized by ASCII characters that depend on the type of command.

The answers given by the HD 9022 are basically of two types: "Information" and "Data"

The former allow information on the status and programming of the HD 9022 to be obtained, as well as the diagnosis of the message received; the latter contain data on the two channels at the moment the request is made.

It is also possible to make use of the serial line for the complete programming of the HD 9022, with the exception of the data transmission speed which may be set only with the keyboard.

The diagnostic replies of the HD 9022 are composed of the following control characters, sent individually (not inserted in the communication frame):

- ack- Command executed (ASCII 06)
- nak- Incorrect command (ASCII 15H)

### COMMAND A

Sub-command	Values	Replies
<b>A</b> Type of terminal	HD 9022	ack/nak
<b>C</b> Company	DELTA OHM	ack/nak
<b>D</b> Firmware Version	Vxx Rxx	ack/nak
<b>E</b> Firmware Date	dd/mm/yy	ack/nak
<b>F</b> Serial Number (rd)	xxxxxx	ack/nak
(wr)	stxAFxxxxxetx	ack/nak

### COMMAND M

Sub-command	Values	Replies
<b>1</b>	Measure Channel 1	ack/nak
<b>2</b>	Measure Channel 2	ack/nak

### RESET COMMAND

Values	Replies
(wr) stxRESETetx	ack/nak

### CHANNEL 1

Sub-command	Values	Replies
<b>C1F01</b> x	Input in	V/A/Pt
<b>C1F02</b> x	Point	0/1/2/3
<b>C1F03</b> xxxx	Start of scale	-9999...19999
<b>C1F04</b> xxxx	V/I Start of scale	0000...10000 (2000 if I)
<b>C1F05</b> xxxx	End of scale	-9999...19999
<b>C1F06</b> xxxx	V/I End of scale	0000...10000 (2000 if I)
<b>C1F07</b> xxxx	Energ. Relay HI	-9999...19999
<b>C1F08</b> xxxx	De-energ. Relay HI	-9999...19999
<b>C1F09</b> xxxx	Energ. Relay LO	-9999...19999
<b>C1F10</b> xxxx	De-energ. Relay LO	-9999...19999
<b>C1F11</b> xxxx	Min Relay Alarm	-9999...19999
<b>C1F12</b> xxxx	Max Relay Alarm	-9999...19999

As regards the command just described, a few remarks must be made:

- There is no command character.
- For the other controls of the type C1F01 etc., the present programming status is supplied for the specific command if only the sequence of the sub-command characters is sent.

Ex: StxC1F01Etx Request from Host  
StxC1F01:1Etx Reply

If the sequence of the sub-command characters is followed by a space and then the desired programming value, the programming of the parameter is produced.

Ex: StxC1F01 1Etx Command from Host  
ack / nak Reply  
StxC1F03 1000Etx Command from Host  
ack / nak Reply  
StxC1F03-2000Etx Command from Host  
ack / nak Reply  
StxC1F0512000Etx Command from Host  
ack / nak Reply

**Note:** for programming of the point F03...F12, the value field has fixed length of 5 characters. The first character in the value field may be a space, the minus sign, or the number 1.

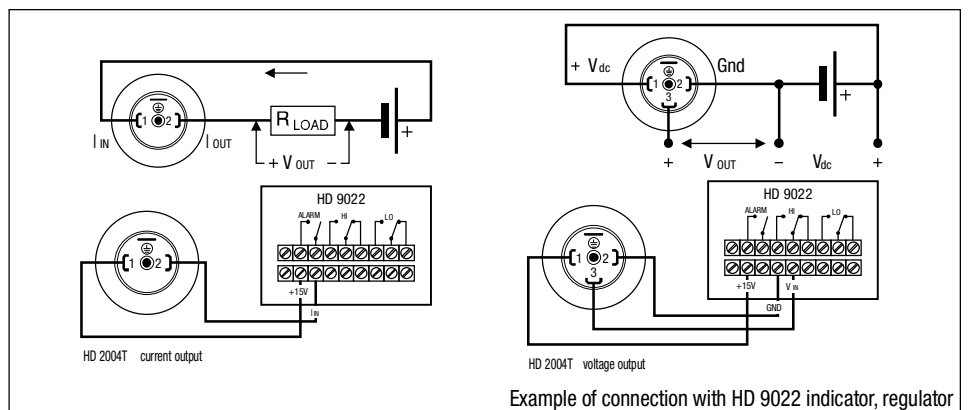
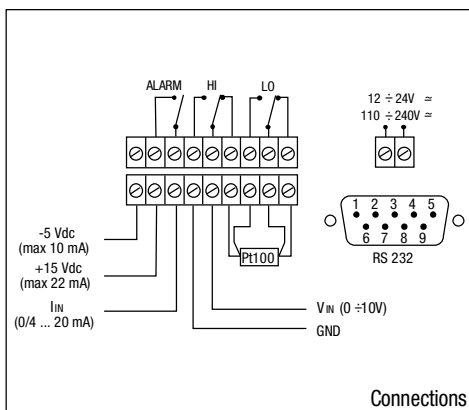

instrument from the keyboard. With ease you can configure the instrument in the field to adapt to changing process requirements. The configurability regards inputs, extension ladders, set points, alarms and the baud rate.

### Applications

A typical application of the DO 9404 is the display and regulation of signals arriving from passive 2-wire or active 3-wire transmitters, of any physical quantity: temperature, humidity, pressure, speed, level, etc. for a wide variety of industrial sectors and automation.

### Specifications

- Set point may be configured from -9999 to +19999
- Indication with 1/2" red LEDs
- Separate terminal for each channel for voltage input 0÷10 V and current input 0÷20 mA, 4÷20 mA
- On the terminal board an auxiliary power supply is available at -5 Vdc max. 10 mA and +15 Vdc non-stabilized max. 44 mA for the possible feeding of passive 2-wire transmitters
- Instrument accuracy  $\pm 0.1\% \text{ Rdg} \pm 1 \text{ digit}$
- A/D converter resolution: 0.05 mV/digit, 1  $\mu\text{A}$ /digit
- Functions:
  - Two relays with insulated HI LO exchange contact for channel 1: RL1, RL2
  - Two relays with insulated HI LO exchange contact for channel 2: RL4, RL5
  - One relay for the overall maximum and minimum alarms: RL3
  - Resistive 3A/230 Vac relay contacts
- Instrument working temperature: (electronic components) -5°C..50°C
- Power supply: 12÷24  $\pm 10\%$  Vac/Vdc.

### Error report

Error signals

The instrument gives error signals in the following cases:

- OFL:** appears when the SET value is set higher than the high alarm value (maximum).
- OFL:** appears when the SET value is set lower than the low alarm value (minimum).
- E1:** appears when a resolution of the AD converter has been asked for that is higher than what is available: **THE MAXIMUM AD RESOLUTION IS 0.1mV/digit or 2 $\mu\text{A}$ /digit.**
- E2:** appears when there is an analog value at input that is lower or higher than that of the instrument: voltage 0 V..+10 V, current 0-20 mA.
- E3:** appears when the values of the alarm thresholds are inverted.
- E4:** reading/writing mistake on the Eeprom.

### Configuration of the regulating indicator DO 9404

- 1) Supply power to the instrument: 11÷30 Vac; 11÷40 Vdc.
- 2) The dual display indicates OFL on both channels (1 and 2) at the first programming, or values depending on previous programming operations.
- 3) When the PROG key is pressed, the message FO appears alternately on channel 1 or 2.
- 4) Select which channel (1 or 2) you want to program, for example channel 1.
- 5) Press the  $\blacktriangle$  key, the message F1 appears; confirm with the ENTER key and the symbol A (Ampere = current signal 0÷20 mA, 4÷20 mA) or the symbol U (voltage V = voltage signal 0÷10 V) appears; with the  $\blacktriangle$  and  $\blacktriangledown$  keys, prepare the input for the desired signal, current A or voltage; for example, set A current input, confirm with the ENTER key, then F1 appears. Press the  $\blacktriangle$  key and the message F2 appears.
- 6) Press the ENTER key, four figures **8888** appear with the decimal point placed at random; using the  $\blacktriangle$  and  $\blacktriangledown$  keys, set the decimal point in the desired position, the possible configurations are:

8888  
8.8  
8.88  
8.888

- 7) Press the ENTER key to confirm, then the message F2 appears; press the  $\blacktriangle$  key and the message F3 appears.
- 8) Press the ENTER key, then using the  $\blacktriangle$  and  $\blacktriangledown$  keys set the start of scale value for channel 1, for example -30.0°C; confirm with ENTER, the message F3 appears, press the  $\blacktriangle$  key and the message F4 appears.
- 9) Press the ENTER key, then using the  $\blacktriangle$  and  $\blacktriangledown$  keys set the analog value corresponding to the start of scale in voltage or current, depending on the choice made in point 5, for example 4.00 mA; confirm with ENTER, the message F4 appears, press the  $\blacktriangle$  key and the message F5 appears.



## DO 9404 DUAL REGULATING INDICATOR WITH MICROPROCESSOR CONFIGURATION AND TWO INPUTS, FOR VOLTAGE OR CURRENT

The DO double indicator controller 9404 is an instrument for panel with LED 96x96 microprocessor with programmable alarm thresholds and user-configurable. Accepts two-channel input signals from two separate transmitters or transmitters by a double. The transmitters can be 2 wires, passive, or 3 wires, active both in tension 0 to 1 V, 0 to 5 V, 0 to 10 V DC 0 to 20 mA, 4 to 20 mA. Configurability for both input channels is always present in the instrument requires no add-on cards.

The choice of configurations for input signals is via the keypad on the front of the instrument. The DO 9404 is equipped with RS232C serial output, the baud rate is configurable from the keyboard, the command is bidirectional, the output connector SUB D 9 pin female. The dimensions of the instrument are in accordance with DIN 45700 96x96 mm, depth 120 mm. The operating mode of the DO 9404 is chosen depending on the application by configuring the

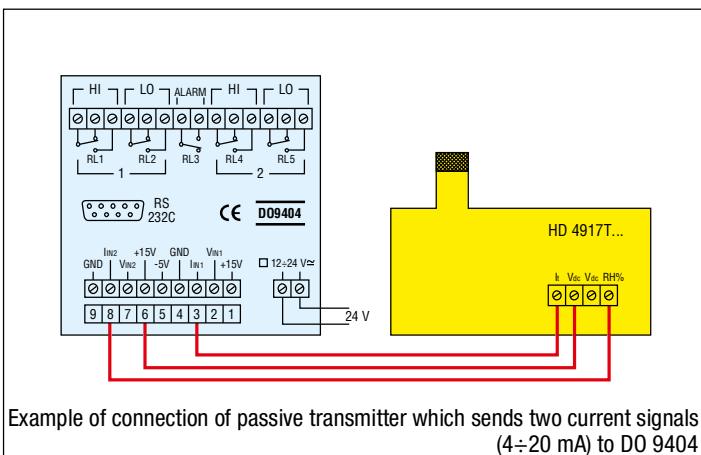

Example of connection of passive transmitter which sends two current signals (4÷20 mA) to DO 9404

Temperature



- 9) Press ENTER , then using the ▲ and ▼ keys set the full scale value for channel 1, for example 130.0°C; confirm with ENTER , the message F5 appears, press the ▲ key and the message F6 appears.
- 10) Press the ENTER key, then using the ▲ and ▼ keys set the analog value corresponding to the end of scale in voltage or current, depending on the choice made in point 5, for example 20.00 mA; confirm with ENTER , the message F6 appears, press the ▲ key and the message F7 appears.
- 11) Press the ENTER key, then using the ▲ and ▼ keys set the SET LO value (closing of contact RL1) for channel 1, for example 0.0°C; confirm with ENTER , the message F7 appears, press the ▲ key and the message F8 appears.
- 12) Press the ENTER key, then using the ▲ and ▼ keys set the Reset HI value (opening of contact RL1) for channel 1, for example 10.0°C; confirm with ENTER , the message F8 appears, press the ▲ key and the message F9 appears.
- 13) Press the ENTER key, then using the ▲ and ▼ keys set the SET LO value (closing of contact RL2) for channel 2, for example 20.0°C (control of a refrigerating unit, for example); confirm with ENTER , the message F9 appears, press the ▲ key and the message F10 appears.
- 14) Press the ENTER key, then using the ▲ and ▼ keys set the Reset HI value (opening of contact RL2) for channel 2, for example 15.0°C (switching off a refrigerating unit, for example); confirm with ENTER , the message F10 appears, press the ▲ key and the message F11 appears.
- 15) Press the ENTER key, then using the ▲ and ▼ keys set the low ALARM value for the relay RL3, for example -5.0°C; confirm with ENTER , the message F11 appears, press the ▲ key and the message F12 appears.
- 16) Press the ENTER key, then using the ▲ and ▼ keys set the high ALARM value for the relay RL3, for example 25.0°C; confirm with ENTER , the message F12 appears, press the ▲ key and the message F13 appears.
- 17) Function F13 is used to select the baud rate for serial transmission; press the ENTER key and a baud rate value appears, then using the ▲ and ▼ keys set the desired rate, choosing one of the following: 300, 600, 1200, 2400, 4800, 9600; the other serial transmission parameters are fixed and cannot be changed; they are:

8 bit  
No Parity  
1 Stop bit

Note: the baud rate is the same for both channels. Press ENTER to confirm, press the ▼ key until FO appears indicating the end of programming; press the ENTER key. This operation concludes the programming of channel 1 as described up to this point.

- Programming is the same for both channels, 1 and 2; all that has been described for channel 1 also applies to channel 2.
  - The function of the set and reset relays (close LO contact, open HI contact), of relays RL1 and RL2 or RL4 and RL5, depends on what the process requires.
  - To alter the parameters it is sufficient to enter the program by pressing the PROG key; when FO appears, choose the channel in which you want to change the parameter, press the ▲ key until the function that you want to change appears, then make the change with the ▲ and ▼ keys; press ENTER to confirm, then return to FO function with the ▼ key, press ENTER thus returning to normal operation.
  - In normal operation, pressing one of the ▲ or ▼ keys passes from the measurement of the physical quantity to the voltage or current value corresponding to the measurement in progress; this applies to both channels.
- When one of the or keys is pressed the instrument returns to normal measuring status.
- The serial interface is active only during normal operation.
  - The programming parameters remain in the memory even when the instrument is receiving no power.

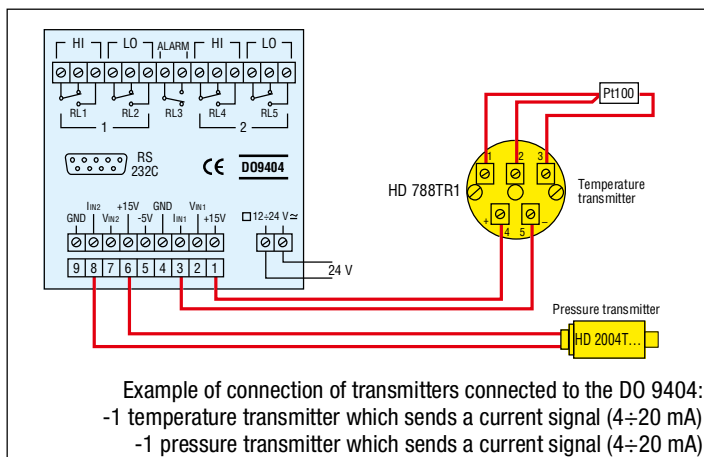

- The relays are disconnected during programming.

### Serial interface RS-232C

The DO 9404 is equipped with standard serial interface RS-232C which is available on the SUB D female 9-pin connector. The arrangement of the signals on this connector is as follows;

Pin	Signal	Description
2	TD	Datum transmitted by the DO 9404
3	RD	Datum received by the DO 9404
5	GND	Reference logic mass

The transmission parameters with which the instrument is supplied are:

- baud rate 9600 baud
- parity None
- n. bits 8
- stop bit 1

The data transmission speed may be changed by altering the set-up parameter F13 with the keyboard; the possible baud rates are: 9600, 4800, 1200, 600, 300. The other transmission parameters are fixed.

All the messages reaching and leaving the DO 9404 must be inserted in a "Communication frame" with the following structure:

<Stx>      <Record>      <Etx>  
 where:  
 <Stx>      Start of text (ASCII 02)  
 <Record>    constitutes the message  
 <Etx>      End of text (ASCII 03)

### Host commands

The structure of the command records is as follows:

<Command character><Sub-command><Values>

Where:

- <Command character> is characterized by an alphabetic character indicating the set of commands.
- <Sub-command> is characterized by a character indicating the type of command.
- <Values> is characterized by ASCII characters that depend on the type of command.

The replies provided by the DO 9404 are essentially of two types: "Information" and "Data".

The former allow information on the status and programming of the DO 9404 to be obtained, as well as the diagnosis of the message received; the latter contain data on the two channels at the moment the request is made. It is also possible to make use of the serial line for the complete programming of the DO 9404, with the exception of the data transmission speed which may be set only with the keyboard.

The diagnostic replies of the DO 9404 are composed of the following control characters, sent individually (not inserted in the communication frame):

- ack-      Command executed (ASCII 06)
- nak-      Incorrect command (ASCII 15H)

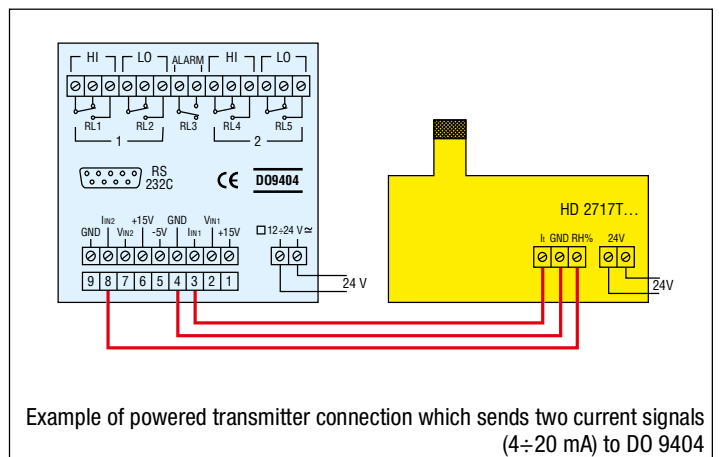

**COMMAND A**

Sub-command	Values	Replies
<b>A</b> Type of terminal		DO 9404
<b>C</b> Company		DELTA OHM
<b>D</b> Firmware Version		Vxx Rxx
<b>E</b> Firmware Date		dd/mm/yy
<b>F</b> Serial number	(rd) (wr) xxxxxx	AFxxxxx ack/nak

**COMMAND M**

Sub-command	Values	Replies
<b>1</b> Measure Channel 1		Measure Channel 1
<b>2</b> Measure Channel 2		Measure Channel 2

**RESET COMMAND**

<b>RESET</b>	(wr)	Values	Replies
--------------	------	--------	---------

**COMMAND**

Sub-command	Values	Replies
<b>1</b> Set-up Channel 1		Set-up Channel 1
<b>2</b> Set-up Channel 2		Set-up Channel 2

**CHANNEL 1**

<b>C1F01</b> x	Input in	V/A	ack/nak
<b>C1F02</b> x	Point	0/1/2/3	ack/nak
<b>C1F03</b> xxxx	Start of scale	-9999...19999	ack/nak
<b>C1F04</b> xxxx	V/I Start of scale	0000...10000 (2000 if I)	ack/nak
<b>C1F05</b> xxxx	End of scale	-9999...19999	ack/nak
<b>C1F06</b> xxxx	V/I End of scale	0000...10000 (2000 if I)	ack/nak
<b>C1F07</b> xxxx	Energ. Relay 1	-9999...19999	ack/nak
<b>C1F08</b> xxxx	De-energ. Relay 1	-9999...19999	ack/nak
<b>C1F09</b> xxxx	Energ. Relay 2	-9999...19999	ack/nak
<b>C1F10</b> xxxx	De-energ. Relay 2	-9999...19999	ack/nak
<b>C1F11</b> xxxx	Min1 Relay 3	-9999...19999	ack/nak
<b>C1F12</b> xxxx	Min1 Relay 3	-9999...19999	ack/nak
<b>C1F12</b> xxxx	Max1 Relay 3	0000-9999	ack/nak

**CHANNEL 2**

<b>C2F01</b> x	Input in	V/A	ack/nak
<b>C2F02</b> x	Point	0/1/2/3	ack/nak
<b>C2F03</b> xxxx	Start of scale	-9999...19999	ack/nak
<b>C2F04</b> xxxx	V/I Start of scale	0000...10000 (2000 if I)	ack/nak
<b>C2F05</b> xxxx	End of scale	-9999...19999	ack/nak
<b>C2F06</b> xxxx	V/I End of scale	0000...10000 (2000 if I)	ack/nak
<b>C2F07</b> xxxx	Energ. Relay 4	-9999...19999	ack/nak
<b>C2F08</b> xxxx	De-energ. Relay 4	-9999...19999	ack/nak
<b>C2F09</b> xxxx	Energ. Relay 5	-9999...19999	ack/nak
<b>C2F10</b> xxxx	De-energ. Relay 5	-9999...19999	ack/nak
<b>C2F11</b> xxxx	Min2 Relay 3	-9999...19999	ack/nak
<b>C2F12</b> xxxx	Max2 Relay 3	-9999...19999	ack/nak

Regarding the command just described, a few remarks must be made:

- There is no command character.
- In the first two cases (Sub-command 1 and 2) the complete set-up of the DO 9404, for Channel 1 and for Channel 2, is made available in the serial line.
- For all the other controls of the type C1F01 etc., the present programming status is supplied for the specific command if only the sequence of the subcommand characters is sent.

Example: StxC1F01Etx Request from Host  
StxC1F01:1Etx Reply

If the sequence of the sub-command characters is followed by a space and then the desired programming value, the programming of the parameter is produced.

Example: StxC1F01 1Etx Command from Host  
ack / nak Reply

**Note:** for programming of the point F03...F12, the value field has fixed length of 5 characters. The first character in the value field may be a space, the minus sign, or the number one.

StxC1F03 1000Etx Request from Host  
Host ack / nak Reply  
StxC1F03-2000Etx Request from Host  
Host ack / nak Reply  
StxC1F0512000Etx Request from Host  
Host ack / nak Reply

Temperature

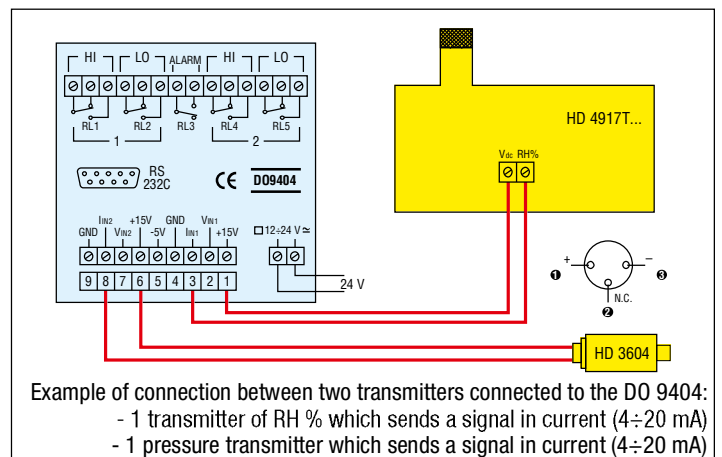
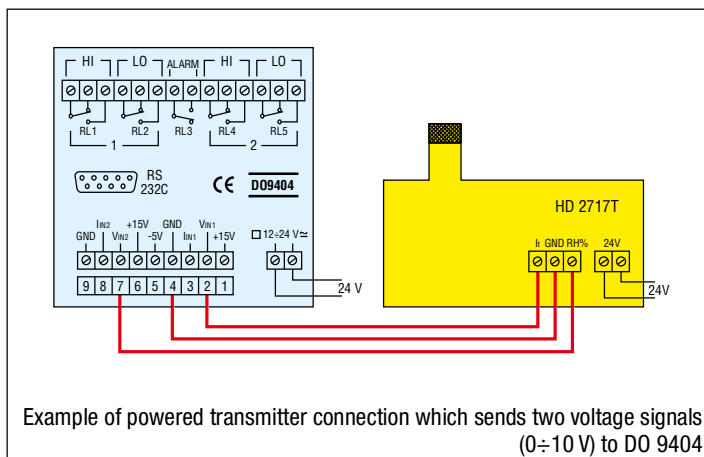



SIT N° 124 Laboratory for temperature

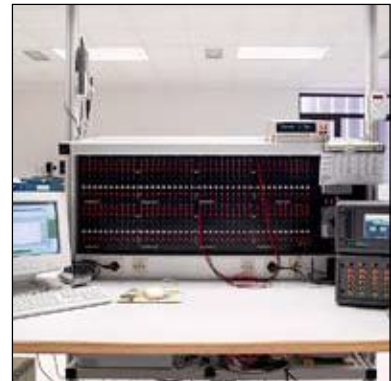





## Calibration Service in Italy

SIT centre n° 124:  
 DELTA OHM s.r.l.  
 Via G. Marconi, 5  
 35030 CASELLE DI SELVAZZANO (PD) - ITALIA  
**Telefono:** +39 049 89 77 150  
**Telefax:** +39 049 63 55 96  
**E-mail:** deltaohm@tin.it  
**URL** <http://www.deltaohm.com>

### Permanent Laboratory

### SIT ACCREDITATION TABLE

Quantity	Instrument to calibrate	Measuring range	Uncertainty (*)	Note
Temperature	Noble metal thermocouples	-196 °C, -80°C...250°C 250°C ... 600°C 600°C ... 1100°C 1100°C...1250°C	0,4 °C 0,3 °C 0,4 °C 1,0 °C 2,0 °C	
	Common metal thermocouples	-196 °C, -80°C...250°C 250°C ... 600°C 600°C ... 1100°C 1100°C...1250°C	0,40 °C 0,40 °C 0,53 °C 1,1 °C 2,2 °C	
	Resistance thermometers	-196 °C, -80°C...250°C 0°C ... 100°C 100°C ... 250°C 250°C...600°C	0,20 °C 0,15 °C 0,05 °C 0,10 °C 0,20 °C	
	Thermometric chains Indicators for - Noble metal thermocouples	-196 °C, -80°C...250°C 250°C ... 600°C 600°C ... 1100°C 1100°C...1250°C	$2\sqrt{0,20^2 + u_{ris}^2}$ °C $2\sqrt{0,15^2 + u_{ris}^2}$ °C $2\sqrt{0,20^2 + u_{ris}^2}$ °C $2\sqrt{0,50^2 + u_{ris}^2}$ °C $2\sqrt{1,0^2 + u_{ris}^2}$ °C	□
	Thermometric chains Indicators for - Noble metal thermocouples	-196 °C, -80°C...250°C 250°C ... 600°C 600°C ... 1100°C 1100°C...1250°C	$2\sqrt{0,20^2 + u_{ris}^2}$ °C $2\sqrt{0,20^2 + u_{ris}^2}$ °C $2\sqrt{0,26^2 + u_{ris}^2}$ °C $2\sqrt{0,55^2 + u_{ris}^2}$ °C $2\sqrt{1,1^2 + u_{ris}^2}$ °C	□
	- Resistances	-196°C -80°C ... 250°C 0°C ... 100°C 100°C ... 250°C 250°C ... 600°C	$2\sqrt{0,10^2 + u_{ris}^2}$ °C $2\sqrt{0,075^2 + u_{ris}^2}$ °C $2\sqrt{0,025^2 + u_{ris}^2}$ °C $2\sqrt{0,050^2 + u_{ris}^2}$ °C $2\sqrt{0,10^2 + u_{ris}^2}$ °C	□
	Calibrators-Simulators and Meters - For resistance thermometers - For thermocouples	National and international standards	$2\sqrt{0,025^2 + u_{ris}^2}$ °C $2\sqrt{0,10^2 + u_{ris}^2}$ °C	□

(\*)The measuring uncertainties are expressed as corresponding to a confidence level of about 95%.

□  $u_{ris}$  is the resolution of the instrument (1 digit or 1/2 division) or uncertainty of multimeter to which it will be connected with

